



GM

MODULAR BAYONET CONNECTORS

Flexible solution for power, signals and
data transmission in harsh environment



Radiall 

 VanSystem

About Us



Radiall has been enabling technology and innovation through collaboration with customers since 1952.

This has resulted in a range of innovative and award-winning products that customers trust for unrivaled repeatability and performance. Radiall's success is built on strong customer relationships and quality components, which have been established since its foundation.

With a focus on simplification and innovation, Radiall has become an industry leader in providing innovative solutions to customers. From connectors to in-house technologies, Radiall's commitment to collaboration and innovation has made it a trusted partner for customers looking to build the future.



The VanSystem brand in the Radiall world distinguishes "heavy duty" connectors for railways and industrial applications.

The name origin is related to VanSystem, an Italian company founded in Milan in 1985 and specialized in the design and production of industrial connectors.

During 30 years of activity the company has gained a strong market position by developing interconnection solutions compliant with the SAE AS 50151 (ex MIL-DTL-5015) standard and tailor-made connectors for the railway, machine tools, automation, construction sites, power supply, extractive industries markets.

In 2015 Radiall SA took over the company; Radiall Italia was born in 2021, from the merger between VanSystem srl and Radiall Elettronica srl.

Radiall Italia S.r.l. Quality System is qualified according ISO 9001:2015 and ISO/TS 22163:2017 (IRIS)



GM Connectors - Introduction

Modular Bayonet Connectors



GM

Modular Connectors:

GM connectors are designed for accepting modules for many different applications: Ethernet and Data Transmission, Coaxial connections, Fibre optics, Power cables, Signals up to 14 wires. Each module is pneumatically sealed in its housing (the connector is suitable for pressurized cabin). Plastic hard insert offers positive module rear release retention.

Features:

- Bayonet coupling system, directly derived from the reliable CVBS series
- 5 keyed guiding system, mechanical coding, variable combined polarization system
- High grade efficiency shielding for each module's EMI/RFI protection
- Audible, visible and tactile mating. One quarter turn lock for coupling
- Comply all requirements of transit applications
- IP67 rating (according to EN 60529)
- Rubber coated coupling nut offers damping protection against mechanical shock



GMM

Power, Signal and Data transmission modules:

GMM modules are designed for many different applications:

- Ethernet and data transmission (Cat. 7A Tested according to Trenitalia 376575, Cat. 7, 6A, 6, 5E, 5, MVB, RS485, WTB)
- Coaxial connections (RG cables, application Wi-Fi 2.4GHz & 5 GHz, GSMR, GPS, WLAN)
- Fibre optics (Accepted optical contacts SC type, 2/4 Expanded Beam)
- Power connection, signals up to 14 wires

High level of performance:

- EMI protection, each module is shielded alone with grounding finger
- Up to cat. 7A Ethernet data transmission
- Each module is pneumatically sealed and installed in the shell

GM Connectors - Introduction

Modular Bayonet Connectors

GM series is a flexible connection solution for harsh environment application such as Rolling Stock: the insulating materials are in compliance with EN45545-2, the shock-vibrations tests (EN 61373) classified category 2 bogie mounted.

APPLICATIONS:

- Railway Equipment: passenger control, display, internet connection, networking, light control, diagnostic support for brakes, motors and doors
- Energy: power distribution, utilities, mobile generators, loadbanks, back-up power systems
- Naval: Military Field Power
- Industrial: motor controls, automation installation

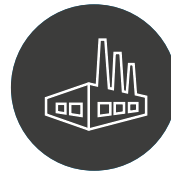

FEATURES & BENEFITS:

Robust Connection

- Fully protected connectors: no risk to damage the modules thanks the robust shell
- Heavy duty rubber covered coupling nut
- Secure connectors suitable with polarizations to prevent un-correct coupling

Easy installation

- Fast and reliable coupling
- Simplified module fixation thanks mechanical clips
- Wide range of backshell and accessories for fastening cable/conduit fixation: single cable relief, heat shrink, metric treaded.

Suitable for harsh environments (adapted for outdoor use)

- Waterproof connection
- Dust proof
- Corrosion resistant

High level of performance

- EMI protection, each modules are shielded alone with grounding finger
- Up to cat. 7A Ethernet data transmission
- Power modular connection from 7,5A to 200A
- Coax cable of many type up to RG217
- Optical fibres with Expanded Beam system or optical SC contacts



GM Connectors - Introduction

Modular Bayonet Connectors

TECHNICAL DETAILS:

- Directly derived from the reliable CVBS series
- 5 keyed guiding system
- Mechanical coding – variable combined polarization system (available for 4 and 7 modules only)
- Audible, visible and tactile mating.
- One quarter turn lock for coupling
- Optical, coax, combined data and power modules available.
- Comply all requirements of transit applications.
- RoHS complying material & finish.
- Rubber coated coupling nut offers damping protection against mechanical shock.
- Available with back-shells expressly designed for single or double headed interconnection between vehicles.

Contacts type	Electrical crimp contacts, Expanded Beam connectors, SC connectors. Electrical Contacts: Copper alloy / Silver or Gold plated
Insert module materials	Rubber inserts or Thermoplastics resin according EN45545-2
Module shell	Aluminum alloy
IP protection degree	IP67 when mated (when used with proper backshell or accessories)
Rated temperature	-55°C ÷ +125 °C
Shell finishes	F7 Black epoxy varnish (<i>RoHS compliance</i>) (not conductive)
	F16 CCF - Black passivation (<i>RoHS compliance</i>) (conductive)
	F26 Hard anodization (<i>RoHS compliance</i>) (not conductive)
Corrosion resistant	500h (F7 shell finishes)
	500h* (F16 shell finishes)
	1000h (F26 shell finishes)

* 200h in case of components, panel and screws in stainless steel (galvanic corrosion)

MECHANICAL CHARACTERISTICS

Coupling mechanism	Reverse Bayonet Connector protected by a stainless steel stud
Mating endurance (IEC 61300-2-2)	500 mating cycles minimum (for use up to 2000 mating cycles, consult our commercial office)
Shock and vibrations tests (EN 61373)	Category 1, Class B, Body Mounted



GM Connectors - Part number explanation

GM 6 RM20 T 24A1 F7 G A01
P/N Sample: GM 6RM20 T 24A1 F7 G A01

GM	Series Code	GM	Modular Connector shell series
6	Shell Type	0	Front mounting receptacle connector
		3	Rear mounting receptacle connector
		38	Rear mounting receptacle connector with 90° elbow
		33	Rear mounting receptacle connector with 30° adaptor
		6	Plug connector for straight backshell
		63	Plug connector for 30° adaptor
		8	Plug connector with 90° elbow
		RM20	Backshell Class
A	Backshell with internal strain relief (without rear thread)		
R**	Backshell class R without rear thread (can be used with grommet)		
RM**	Backshell class M with internal metric thread (can be used with grommet)		
RPMxx***	Backshell with internal metric thread		
RPxx***	Backshell for rubber hose		
SMxx***	Backshell with internal strain relief and metric thread		
SPxx***	Backshell with internal strain relief for rubber hose		
RLMxx***	Sliding Backshell with adapter, with metric thread		
RLPxx***	Sliding Backshell with adapter, for rubber hose		
RJMxx***	Long Backshell for Jumper (to be used with Sliding Backshell), with metric thread		
RJPxx***	Long Backshell for Jumper (to be used with Sliding Backshell), for rubber hose		
SA***	Backshell having an external UNEF thread		
ACF	Backshell with MS 3057...C type cable-clamp		
T	Connector Modification*	-	Without Caps
		T	With Plastic Caps
		FF	Receptacle connector with threaded holes
		FP	Receptacle connector with through holes
		FS	Receptacle connector with countersunk holes
24A1	Size and module number	24A1	Size 24 for 1 module - Type 1 on receptacle, Type 6 on Plug
		40A4	Size 40 for 4 modules - Type 1 on receptacle, Type 6 on Plug
		48A7	Size 48 for 7 modules - Type 1 on receptacle, Type 6 on Plug
		24I1	Size 24 for 1 module - Type 6 on receptacle, Type 1 on Plug
		40I4	Size 40 for 4 modules - Type 6 on receptacle, Type 1 on Plug
		48I7	Size 48 for 7 modules - Type 6 on receptacle, Type 1 on Plug****
F7	Shell finish	F7	Black epoxy varnish (<i>RoHS compliance</i>)
		F16	CCF - Black passivation (<i>RoHS compliance</i>) - conductive
		F26	Hard anodization (RoHS compliance)
G	Panel Gasket	-	Without gasket
		G	Supplied with panel gasket
		G2	Supplied with shielded panel gasket
A01	Modification Code	Axxx	Supplied with modules and grommet (Consult our sales office)
Sxxx		Modification code (Consult our sales office)	

* If Required

** Grommet internal backshell (Page 38)

*** Grommet for cable adapter (Page 39)

**** Each module is not pneumatically sealed in its housing (the connector is not suitable for pressurized cabin).

GM Connectors - Plug connector

Shell type 6

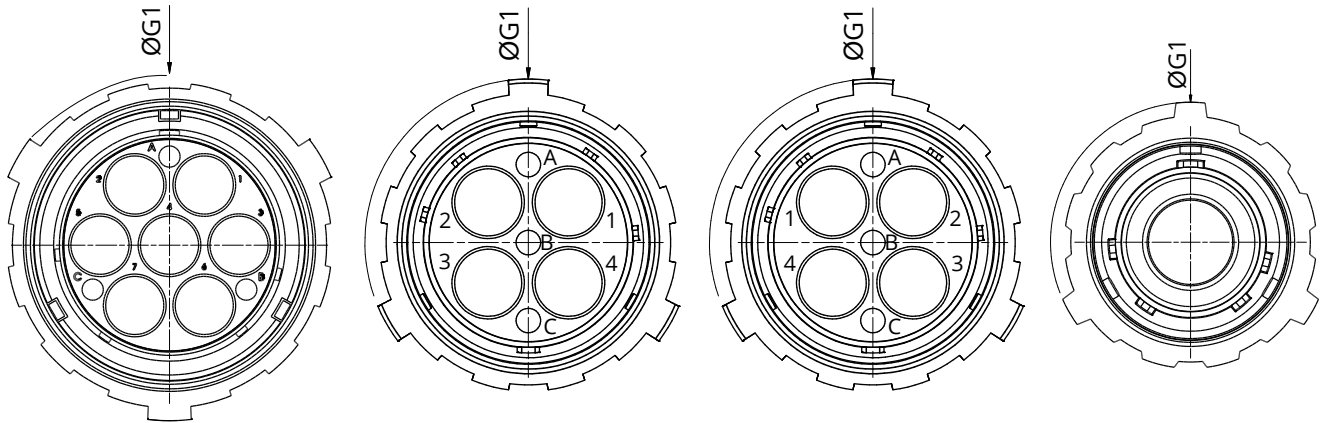

Size 48 and module n° A7/I7

Size 40 and module n° A4

Size 40 and module n° I4

Size 24 and module n° A1/I1

Size & modules n°

ØG1 max.

24A1	24I1	60
40A4	40I4	88
48A7	48I7	109

			Grommet	
			internal backshell	cable adapter
RM20	Backshell Class			
	RM	Backshell class M with internal metric thread (can be used with grommet)	●	-
	RPMxx	Backshell with internal metric thread	-	●
	RPxx	Backshell for rubber hose	-	●
	SMxx	Backshell with internal strain relief and metric thread	-	●
	SPxx	Backshell with internal strain relief for rubber hose	-	●
	RLMxx	Sliding Backshell with internal cable relief and adaptor with metric thread	-	●
	RLPxx	Sliding Backshell with internal cable relief and adaptor, for rubber hose	-	●
	RJMxx	Long Backshell for Jumper (to be used with Sliding Backshell), with metric thread	-	●
	RJPxx	Long Backshell for Jumper (to be used with Sliding Backshell), for rubber hose	-	●
	RPF	Backshell with MS 3057...C type cable-clamp	-	●
	ACF	Backshell with MS 3057...C type cable-clamp	-	-

● Can be used with grommet
Grommet internal backshell (Page 38)
Grommet for cable adapter (Page 39)

GM Connectors - Plug connector

Shell type 6

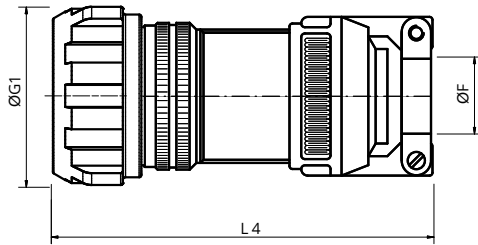

*Backshell class ACF
(cannot be used with grommet, IP65 protection degree EN60529)*

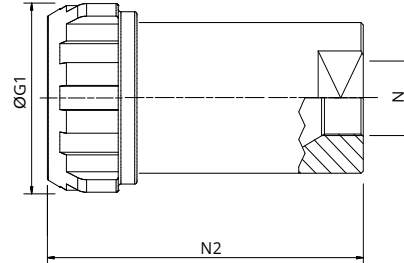

Backshell class RM



Grommet for Backshell Class RM only

Size & modules n°		ØG1 max.	L4 max.	ØF min/max	N2 ±0.5	N thread
24A1	2411	60	92.5	15.5/23.8	80	M25*
40A4	4014	88	112	25.4/35	129	M32*
48A7	4817	109	215	32/41	170	M40*

* Other Metric thread on request

Dimensions in mm

GM Connectors - Plug connector

Shell type 6

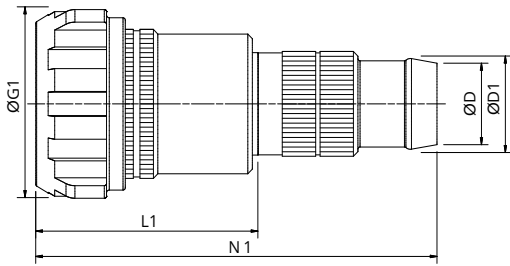

Backshell class RP

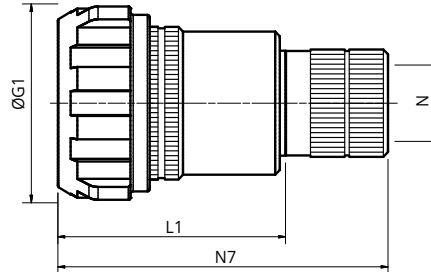

Backshell class RPM



Size & modules n°		ØG1 max.	L1 max.	N1 ±0.5	ØD max.	ØD1 max.	N7 ±0.5	N thread
24A1	24I1	60	n.a.	130	33	38	102	M25*
40A4	40I4	88	105	183	35	40	155	M32*
48A7	48I7	109	151	223	55	60	195	M40*

* Other Metric thread on request

Dimensions in mm

GM Connectors - Plug connector

Shell type 6

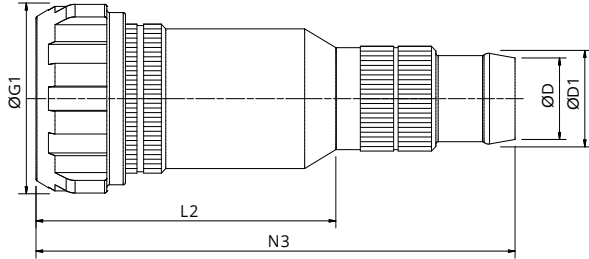

Backshell class SP

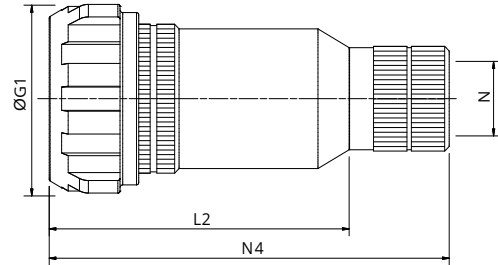

Backshell class SM

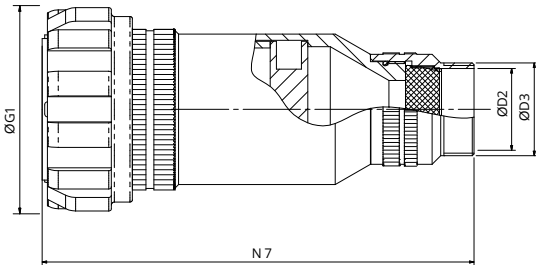

Backshell class SA



Internal strain relief, supplied with Backshell class SP, SA and SM

Backshell class SM

Size & modules n°		ØG1 max.	L2 max.	N3 ±0.5	ØD max.	ØD1 max.	N4 ±0.5	N thread	N7	ØD2	ØD3
24A1	24I1	60	-	-	-	-	-	-	***	***	***
40A4	40I4	88	140	218	35	40	182	M32*	180	32.6	1 7/16 - 18 UNEF
48A7	48I7	109	171	238	**	**	208	M40*	***	***	***

* Other Metric thread on request

** ØD max. according to the conduit type

Dimensions in mm

*** on developing

GM Connectors - Plug connector

Shell type 6

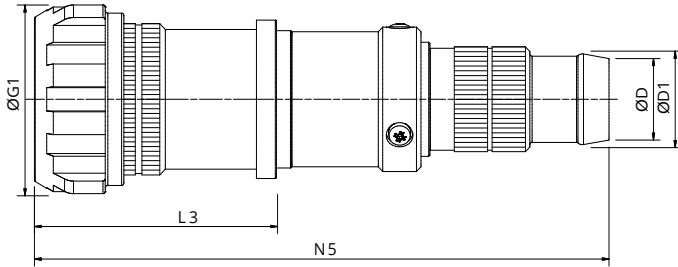

Backshell class RLP

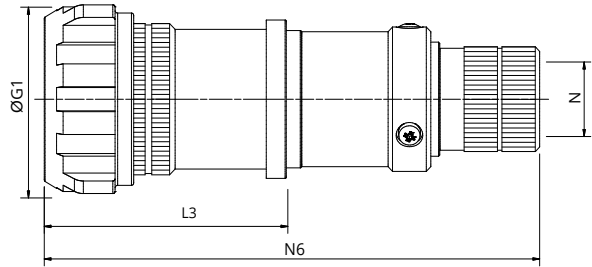

Backshell class RLM

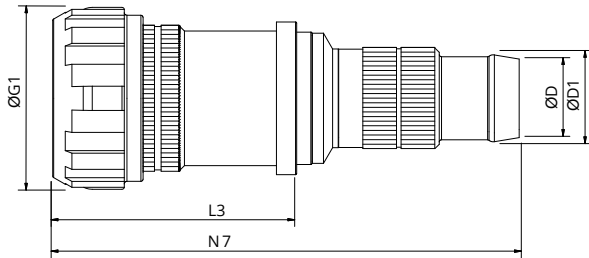

Backshell class RJP

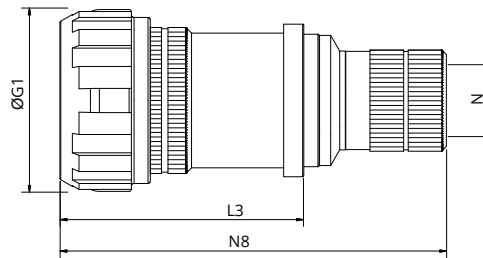

Backshell class RJM



Shell size 40 supplied with Internal cable relief class RLP, RLM, RJP, RJM

Backshell class RJM

Size & modules n°		ØG1 max.	L3 max.	N5 ±0.5	N6 ±0.5	N7 ±0.5	N8 ±0.5	ØD max.	ØD1 max.	N thread
40A4	40I4	88	109	261	225	210	175	**	**	M32*
48A7	48I7	109	153	289	233	240	200	**	**	M40*

* Other Metric thread on request

** ØD max. according to the conduit type

*** on developing

Dimensions in mm

GM Connectors - Receptacle connector

Shell type 0/3

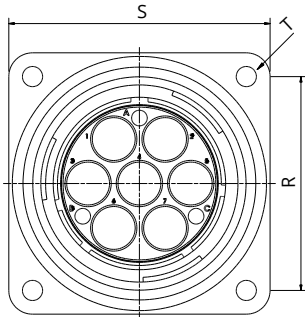

Size 48 and module number A7/I7

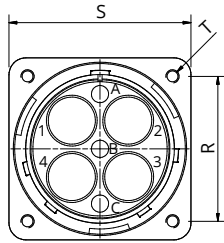

Size 40 and module number A4

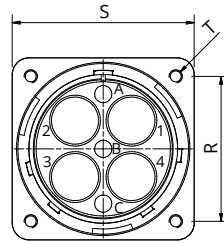

Size 40 and module number I4

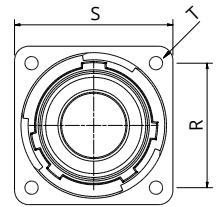

Size 24 and module number A1/I1

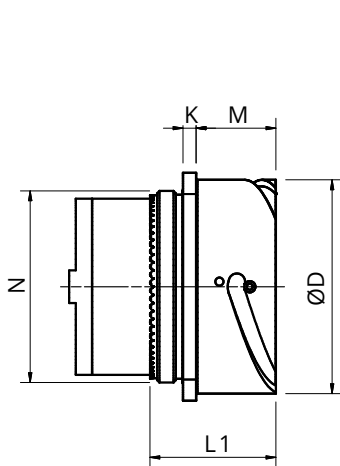

0 Shell type

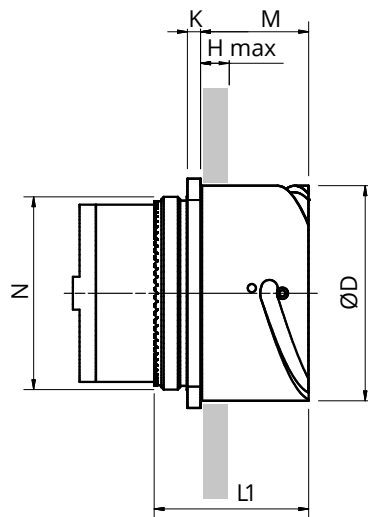

3 Shell type

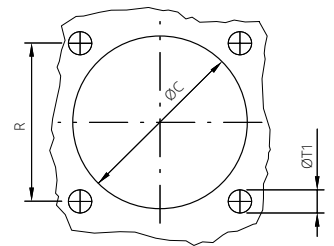

Panel cut out

Shell type 0 front mounting

Size & modules number	ØD +0/-0.15	N Thread	L1 max.	M ±0.2	K ±0.2	S ±0.3	R ±0.1	T	ØT1 Through holes	ØC ±0.2	
24A1	24I1	40.9	1"3/8-18 UNEF	35.9	20.3	4	44.5	34.9	Ø3.7	3.9	36
40A4	40I4	65.5	2"5/16-16 UNS	37.9	22.3	4	69.8	55.6	Ø4.4	4.5	61
48A7	48I7	84	M74X1.5	120	45	8	110	90	Ø8.5	9	76

Shell type 3 rear mounting

Size & modules number	ØD +0/-0.15	N Thread	L1 max.	M ±0.2	K ±0.2	H max.	S ±0.3	R ±0.1	T	ØT1 Threaded holes	ØC ±0.2	
24A1	24I1	40.9	1"3/8-18 UNEF	38.8	23.4	4	6.85	44.5	34.9	M4	4.5	41.8
40A4	40I4	65.5	2"5/16-16 UNS	38.9	24.45	4	7.5	69.8	55.6	M5	5.5	66.4
48A7	48I7	84	M74X1.5	120	45	8	10	110	90	M8	9*	91.8

*Through holes

Dimensions in mm

GM Connectors - Receptacle connector

Shell type 0/3 with backshell

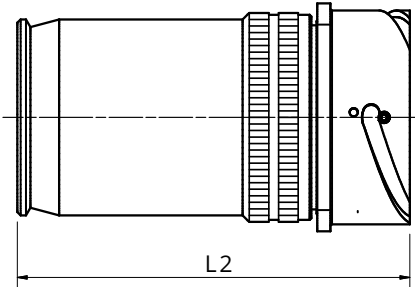

A Backshell class A without rear thread



Internal Strain Relief Disc, supplied with backshell Class A

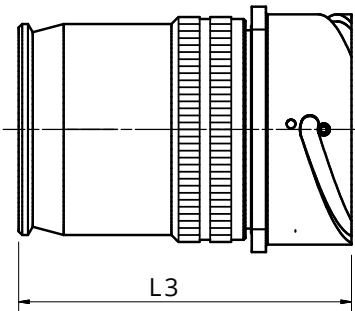

R Backshell class R without rear thread (can be use with grommet page 38)

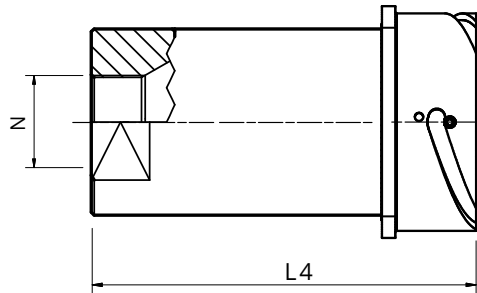

RM Backshell class RM with internal metric thread (can be used with grommet page 38)

Shell type 0 front mounting

Size & modules number	ØD +0/-0.15	L1 max.	L2 max.	L3	L4	N thread	M ±0.2	K ±0.2	S ±0.3	R ±0.1	T	ØT1 Through holes	ØC ±0.2
24A1 24I1	40.9	35.9	122.1	**	**	M20/M25*	20.3	4	44.5	34.9	Ø3.7	3.9	36
40A4 40I4	65.5	37.9	124	98	138	M32*	22.3	4	69.8	55.6	Ø4.4	4.5	61
48A7 48I7	84	120	120	**	**	M40*	45	8	110	90	Ø8.5	9	76

Shell type 3 rear mounting

Size & modules number	ØD +0/-0.15	L1 max.	L2 max.	L3	L4	N thread	M ±0.2	K ±0.2	H max.	S ±0.3	R ±0.1	T	ØT1 Threaded holes	ØC ±0.2
24A1 24I1	40.9	38.8	125	**	**	M20/M25*	23.4	4	6.85	44.5	34.9	M4	4.5	41.8
40A4 40I4	65.5	38.9	125	99	138	M32*	24.45	4	7.5	69.8	55.6	M5	5.5	66.4
48A7 48I7	84	120	120	**	**	M40*	45	8	10	110	90	M8	9*	91.8

** on request

*Through holes

Dimensions in mm

GM Connectors - Connector

Shell finishes: black varnish



Receptacle connector (for shell type module 1)

Part Number	Short Description	Shell Type	Size	N° module	Accessories	Backshell Type	Shell Finishes
On request	GM 0 24A1 F7 G	Front panel mounting	24	1	panel gasket	-	Black Varnish
VS366102	GM 0 40A4 F7 G	Front panel mounting	40	4	panel gasket	-	Black Varnish
VS366103	GM 0 48A7 F7 G	Front panel mounting	48	7	sealing O-ring	-	Black Varnish
VS366104**	GM 3 24A1 F7 G	Rear panel mounting	24	1	panel gasket	-	Black Varnish
VS366105	GM 3 40A4 F7 G	Rear panel mounting	40	4	panel gasket	-	Black Varnish
VS366106	GM 3 48A7 F7 G	Rear panel mounting	48	7	sealing O-ring	-	Black Varnish



Plug connector (for shell type module 6)

Part Number	Short Description	Shell Type	Size	N° module	Accessories	Backshell Type	Shell Finishes
VS366108**	GM 6RM25 24A1 F7	Straight plug	24	1	-	M25 internal threaded	Black Varnish
On request	GM 6ACF 24A1 F7	Straight plug	24	1	-	with MS 3057...C type cable-clamp	Black Varnish
VS366111	GM 6RM32 40A4 F7	Straight plug	40	4	-	M32 internal threaded	Black Varnish
VS366112	GM 6ACF 40A4 F7	Straight plug	40	4	-	with MS 3057...C type cable-clamp	Black Varnish
VS366114	GM 6RM40 48A7 F7	Straight plug	48	7	-	M40 internal threaded	Black Varnish
VS366115	GM 6ACF 48A7 F7	Straight plug	48	7	-	with MS 3057...C type cable-clamp	Black Varnish

** On request

GM Connectors - Connector

Shell finishes: CCF - Black passivation (conductive)



Receptacle connector (for shell type module 1)

Part Number	Short Description	Shell Type	Size	N° module	Accessories	Backshell Type	Shell Finishes
VS366116**	GM 0 24A1 F16 G2	Front panel mounting	24	1	panel gasket*	-	CCF-Black passivation*
VS366117	GM 0 40A4 F16 G2	Front panel mounting	40	4	panel gasket*	-	CCF-Black passivation*
VS366118	GM 0 48A7 F16 G	Front panel mounting	48	7	sealing O-ring	-	CCF-Black passivation*
VS366119**	GM 3 24A1 F16 G2	Rear panel mounting	24	1	panel gasket*	-	CCF-Black passivation*
VS366120	GM 3 40A4 F16 G2	Rear panel mounting	40	4	panel gasket*	-	CCF-Black passivation*
VS366121	GM 3 48A7 F16 G	Rear panel mounting	48	7	sealing O-ring	-	CCF-Black passivation*

* conductive



Plug connector (for shell type module 6)

Part Number	Short Description	Shell Type	Size	N° module	Accessories	Backshell Type	Shell Finishes
VS366123**	GM 6RM25 24A1 F16	Straight plug	24	1	-	M25 internal threaded	CCF-Black passivation*
VS366124**	GM 6ACF 24A1 F16	Straight plug	24	1	-	with MS 3057...C type cable-clamp	CCF-Black passivation*
VS366126	GM 6RM32 40A4 F16	Straight plug	40	4	-	M32 internal threaded	CCF-Black passivation*
VS366127	GM 6ACF 40A4 F16	Straight plug	40	4	-	with MS 3057...C type cable-clamp	CCF-Black passivation*
VS366129	GM 6RM40 48A7 F16	Straight plug	48	7	-	M40 internal threaded	CCF-Black passivation*
VS366130	GM 6ACF 48A7 F16	Straight plug	48	7	-	with MS 3057...C type cable-clamp	CCF-Black passivation*

** On request

* conductive

GM Connectors - Connector

Shell finishes: black varnish



Receptacle connector (for shell type module 6)

Part Number	Short Description	Shell Type	Size	N° module	Accessories	Backshell Type	Shell Finishes
On request	GM 0 24I1 F7 G	Front panel mounting	24	1	panel gasket	-	Black Varnish
On request	GM 0 40I4 F7 G	Front panel mounting	40	4	panel gasket	-	Black Varnish
On request	GM 0 48I7 F7 G *	Front panel mounting	48	7	sealing O-ring	-	Black Varnish
On request	GM 3 24I1 F7 G	Rear panel mounting	24	1	panel gasket	-	Black Varnish
On request	GM 3 40I4 F7 G	Rear panel mounting	40	4	panel gasket	-	Black Varnish
On request	GM 3 48I7 F7 G *	Rear panel mounting	48	7	sealing O-ring	-	Black Varnish

* Each module is not pneumatically sealed in its housing (the connector is not suitable for pressurized cabin).



Plug connector (for shell type module 1)

Part Number	Short Description	Shell Type	Size	N° module	Accessories	Backshell Type	Shell Finishes
On request	GM 6RM25 24I1 F7	Straight plug	24	1	-	M25 internal threaded	Black Varnish
On request	GM 6ACF 24I1 F7	Straight plug	24	1	-	with MS 3057...C type cable-clamp	Black Varnish
On request	GM 6RM32 40I4 F7	Straight plug	40	4	-	M32 internal threaded	Black Varnish
On request	GM 6ACF 40I4 F7	Straight plug	40	4	-	with MS 3057...C type cable-clamp	Black Varnish
On request	GM 6RM40 48I7 F7 *	Straight plug	48	7	-	M40 internal threaded	Black Varnish
On request	GM 6ACF 48I7 F7 *	Straight plug	48	7	-	with MS 3057...C type cable-clamp	Black Varnish

* Each module is not pneumatically sealed in its housing (the connector is not suitable for pressurized cabin).

GM Connectors - Connector

Shell finishes: CCF - Black passivation (conductive)



Receptacle connector (for shell type module 6)

Part Number	Short Description	Shell Type	Size	N° module	Accessories	Backshell Type	Shell Finishes
On request	GM 0 2411 F16 G2	Front panel mounting	24	1	panel gasket*	-	CCF-Black passivation*
On request	GM 0 40I4 F16 G2	Front panel mounting	40	4	panel gasket*	-	CCF-Black passivation*
On request	GM 0 48AI7 F16 G **	Front panel mounting	48	7	sealing O-ring	-	CCF-Black passivation*
On request	GM 3 2411 F16 G2	Rear panel mounting	24	1	panel gasket*	-	CCF-Black passivation*
On request	GM 3 40I4 F16 G2	Rear panel mounting	40	4	panel gasket*	-	CCF-Black passivation*
On request	GM 3 48I7 F16 G **	Rear panel mounting	48	7	sealing O-ring	-	CCF-Black passivation*

** Each module is not pneumatically sealed in its housing (the connector is not suitable for pressurized cabin).

* conductive



Plug connector (for shell type module 1)

Part Number	Short Description	Shell Type	Size	N° module	Accessories	Backshell Type	Shell Finishes
On request	GM 6RM25 24I1 F16	Straight plug	24	1	-	M25 internal threaded	CCF-Black passivation*
On request	GM 6ACF 24I1 F16	Straight plug	24	1	-	with MS 3057...C type cable-clamp	CCF-Black passivation*
On request	GM 6RM32 40I4 F16	Straight plug	40	4	-	M32 internal threaded	CCF-Black passivation*
On request	GM 6ACF 40I4 F16	Straight plug	40	4	-	with MS 3057...C type cable-clamp	CCF-Black passivation*
On request	GM 6RM40 48I7 F16 **	Straight plug	48	7	-	M40 internal threaded	CCF-Black passivation*
On request	GM 6ACF 48I7 F16 **	Straight plug	48	7	-	with MS 3057...C type cable-clamp	CCF-Black passivation*

** Each module is not pneumatically sealed in its housing (the connector is not suitable for pressurized cabin).

* conductive

GM Connectors - Connector

Shell finishes: black varnish



Plug connector (for shell type module 6)

Part Number	Short Description	Shell Type	Size	N° module	Accessories	Backshell Type	Shell Finishes
on request	GM 8RP4540 40A4 F7	Plug connector with 90° elbow	40	4	-	for rubber hose 4540	Black Varnish

Shell finishes: CCF - Black passivation (conductive)



Plug connector (for shell type module 6)

Part Number	Short Description	Shell Type	Size	N° module	Accessories	Backshell Type	Shell Finishes
on request	GM 8RP4540 40A4 F16	Plug connector with 90° elbow	40	4	-	for rubber hose 4540	CCF-Black passivation

** On request

GM Connectors - Plug connector

Shell type 8

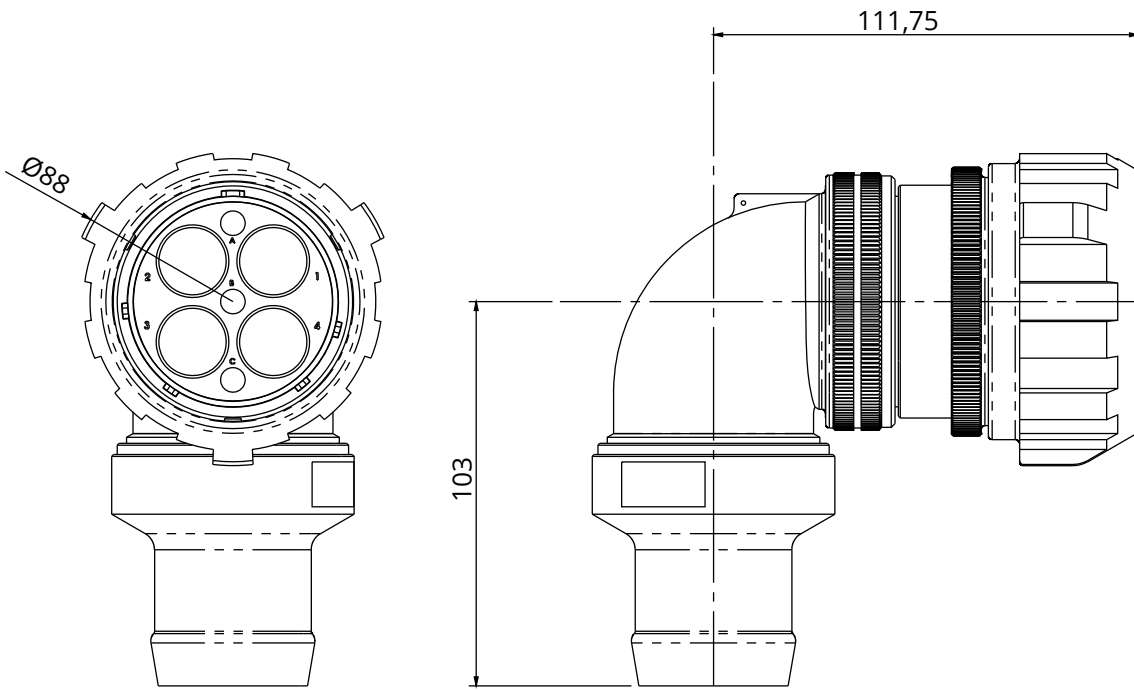

Dimensions in mm

RPxx	Backshell Class	RPxx**	Backshell for rubber hose
-------------	------------------------	---------------	---------------------------

** Grommet on request (Page 32)

GMM Modules - Introduction

Power, Signal and Data transmission modules



MODULE TYPE

Materials and finishes:

Shell	Aluminum alloy – Electro-less nickel plated or thermoplastic version
Contacts	Copper alloy – Gold or silver plating over Nickel
Insulator	Thermoplastic /rubber fire resisting complies EN 45545-2 - NFPA 130 (ASTM E 162, ASTM E 662, BSS 7239)

Module type	Data Transmission Coaxial cables	N° Poles	Rated Current	Rated Voltage	Contact size	Wire section mm ²	AWG	Contact Type	Contact plated
C7	cat. 7A / 7 / 6A	2x4	-	-	-	-	23÷24	crimp	gold
14Z8	cat. 6 / 5e	2x4	-	-	-	0,6	20	crimp	gold
14S2	cat. 5 / MVB / RS485	4	-	-	-	0,15÷0,6	26÷20	crimp	gold
14S9	WTB	2	-	-	-	0,15÷0,6	26÷20	crimp	gold
FOSC3	SC optical fiber	3	-	-	-	-	-	crimp	-
FOEB2	Expanded Beam SM / MM	2	-	-	-	-	-	crimp	-
FOEB4	Expanded Beam SM / MM	4	-	-	-	-	-	crimp	-
C8	RG58 / RG59 / RG179 / RG187	1	-	-	-	-	-	-	-
C4	RG59	1	-	-	-	-	-	-	-
C4R	Wi-Fi 2.4GHz & 5 GHz GSMR / GPS / WLAN	1	-	-	-	-	-	-	-
P4	-	1	80A	200V	4	-	4	crimp	silver*/ (gold)
P8	-	1	46A	200V	8	-	8	crimp	silver*/ (gold)
P3-13	-	2+PE	13A	200V	-	2,5	-	crimp	silver*/ (gold)
14S7	-	3	13A	500V	16	1,00 ÷ 1,50	18 ÷ 16	crimp	gold* / (silver)
14S5	-	5	13A	200V	16	1,00 ÷ 1,50	18 ÷ 16	crimp	gold* / (silver)
14S6	-	6	13A	200V	16	0,15 ÷ 0,60	26 ÷ 20	crimp	gold* / (silver)
14SA7	-	7	13A	200V	16	0,15 ÷ 0,60	26 ÷ 20	crimp	gold* / (silver)
14Z10	-	10	7,5A	200V	20	0,6	20	crimp	gold* / (silver)
14Z12	-	12	7,5A	200V	20	0,6	20	crimp	gold* / (silver)
14Z14	-	14	7,5A	200V	20	0,6	20	crimp	gold* / (silver)

Terminations for other section can be supplied on request.

* Standard contacts plating

GMM Modules - Part number explanation

GMM
6
XE
14Z10
P
A09
N04

P/N Sample: GMM 6XE 14Z10P A09 N04

GMM	Series Code	GMM	Modular inserts series
6	Module Type	1	Module for receptacle connectors (shell type 0 / 3, version 24A1, 40A4, 48A7) Module for plug connectors (shell type 6 / 8, version 24I1, 40I4, 48I7)
		6	Module for plug connectors (shell type 6 / 8, version 24A1, 40A4, 48A7) Module for receptacle connectors (shell type 0 / 3, version 24I1, 40I4, 48I7)
XE	Backshell Class	A	Short backshell (the module is supplied without EMI grounding finger)
		XA	Adapter for heat shrink tube for wire diameter 10,2mm
		GV	Adapter with shielding nut and cone for wire diameter 9,3mm
		XE	Adapter for crimping sleeve and heat shrink tube
		EII	Double spring adapter (strain relief & shielding) for cable Ø 7 ÷ Ø 10,1 mm
		C7	cat. 7A / 7 / 6A
		14Z8	cat. 6 / 5e
		14S2	cat. 5 / MVB / RS485
		14S9	WTB
		FOSC3	SC optical fiber connectors
14Z10	Insert arrangement	FOEB2S	Expanded Beam, Single Mode, 2 channel connectors
		FOEB4S	Expanded Beam, Single Mode, 4 channel connectors
		FOEB2M	Expanded Beam, Multi Mode, 2 channel connectors
		FOEB4M	Expanded Beam, Multi Mode, 4 channel connectors
		C8	RG58 / RG59 / RG179 / RG187
		C4	RG59
		C4R	Wi-Fi 2.4GHz & 5 GHz / GSMR / GPS / WLAN
		P4	1 pole, 80A
		P8	1 pole, 46A
		13P3	3 poles, 13A
		14S7	3 poles, 13A
		14S5	5 poles, 13A
		14S6	6 poles, 13A
		14SA7	7 poles 13A
14Z10	10 poles, 7,5A		
14Z12	12 poles, 7,5A		
14Z14	14 poles, 7,5A		
P	Contact gender	P	Pin insert
		S	Socket insert
A09	Cable diameter	A05	XE Module for cables up to Ø 5mm
		A06	XE Module for cables up to Ø 6mm
		A09	XE Module for cables up to Ø 9mm
		A07	GV Module for cables up to Ø 7.5mm
		A10	GV Module for cables up to Ø 10mm
		A11	XE Module for cables up to Ø 11mm
		A13	GV Module for cables up to Ø 13.5mm
N04	Contact type	LC	Module supplied without contacts
		N01	Contacts (ST485 16SP/SS) for wire section 1 ÷ 1,50mm ² , AWG 18-16 (14S module)
		N02	Contacts (ST485 16S-13P/S) for wire section 0,15 ÷ 0,60mm ² , AWG 26-20 (14S module)
		N03	Contacts for AWG 24 - AWG 23 (C7 module)
		N04	Contacts (CT485 20S/P) for wire section 0,60 mm ² , AWG 20 (14Z module)
		N05	Contacts for wire section 2,50 mm ² , (13P3 module)
		N06	Contacts for AWG 4 (P4 module)
		N07	Contacts for 6mm ² - AWG 10 (P8 module)
		N08	Contacts for 25mm ² (P4 module)
		N09	Contacts (ST485 16S-11P/S) for 0,25 ÷ 0,5mm ² (14S module)
N10	Contacts (ST485 16S-12P/S) for 0,6 mm ² ÷ 0,75mm ² - AWG 20 (14S module)		
	Contact Plating	-	Gold Plated Contact for Data Module or Silver Plated Contact for Power Module
		S	Silver Plated Contact for Data Module
		D	Gold Plated Contact for Power Module

GMM Modules - C7 Module

Ethernet Cat 6A - Ethernet Cat 7 - Ethernet Cat 7A

- Match CAT 7A requirements.
- Tested according to Trenitalia 376575.
- Over-moulded contacts pairs at controlled impedance.
- Each pair is fully shielded from the adjacent to reduce the crosstalk.
- 2x4 contact termination AWG 23 (available AWG24 and AWG26 on request).
- Reduced components quantity makes easier and more reliable assembly.



- Cable TECNİKABEL 522E0048 ETHERNET CABLE 4 PAIRS 23AWG CAT7A (For jumper railway application tested up to 10meters)
- Cable BELDEN BE43801 CAT7 ETHERNET RAILCABLE 4 PR AWG24/16 S/FTP
- Cable HUBER+SUHNER RADOX RAILCAT CAT7 100 OHM 4X (2X2X24AWG) XM S
- Cable Nexans Filotex® 2PM577 FLAMEX - HALOGEN FREE 4x(2x0.25 mm²) ETHERNET CAT6A - tested up to 10meters
- Cable Nexans Filotex® 2PM615 FLAMEX - HALOGEN FREE ETHERNET CATEGORY 7 4x(2x0.25 mm²) - tested up to 10meters
- Cable Nexans Filotex® 2PM617 FLAMEX - HALOGEN FREE ETHERNET CATEGORY 7A 4x(2x0.25 mm²) - tested up to 10meters

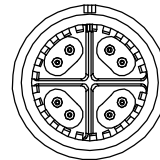

Pin insert

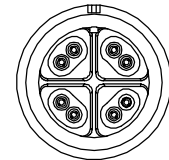

Socket insert

Module Type 1 for receptacle connectors (shell type 0 / 3, version 24A1, 40A4, 48A7)

Module Type 1 for plug connectors (shell type 6 / 8, version 24I1, 40I4, 48I7)

Part Number	Short Description	N° Poles	Ethernet	Contact Gender	Wire Section mm ²	AWG	Contact Type (size)	Contact plated
VS366131	GMM 1EII C7P N03	2x4	Cat. 6A - Cat. 7 - Cat. 7A	Pin	-	24 - 23	crimp	gold
VS366132*	GMM 1GV C7P N03	2x4	Cat. 6A - Cat. 7	Pin	-	24 - 23	crimp	gold

Module Type 6 for plug connectors (shell type 6 / 8, version 24A1, 40A4, 48A7)

Module Type 6 for receptacle connectors (shell type 0 / 3, version 24I1, 40I4, 48I7)

Part Number	Short Description	N° Poles	Ethernet	Contact Gender	Wire Section mm ²	AWG	Contact Type (size)	Contact plated
VS366133	GMM 6EII C7S N03	2x4	Cat. 6A - Cat. 7 - Cat. 7A	Socket	-	24 - 23	crimp	gold
VS366134*	GMM 6GV C7S N03	2x4	Cat. 6A - Cat. 7	Socket	-	24 - 23	crimp	gold

* on developing

Terminations for other section can be supplied on request

Backshell Class	GV	EII
GV	Adapter with shielding nut and cone for wire diameter 9,3mm (Ø 7,5 mm or Ø 10 mm on request)	
EII		Double spring adapter (strain relief & shielding) for cable Ø 7 ÷ Ø 10,1 mm

Materials and finishes:

Shell	Aluminum alloy – Electro-less nickel plated
Contacts	Copper alloy – Gold plating over Nickel
Insulator	Controlled impedance thermoplastic resin

GMM Modules - C7 Module

Ethernet Cat 6A - Ethernet Cat 7 - Ethernet Cat 7A

The module must be fitted in the shell according the orientation key

Plug with Socket Modules

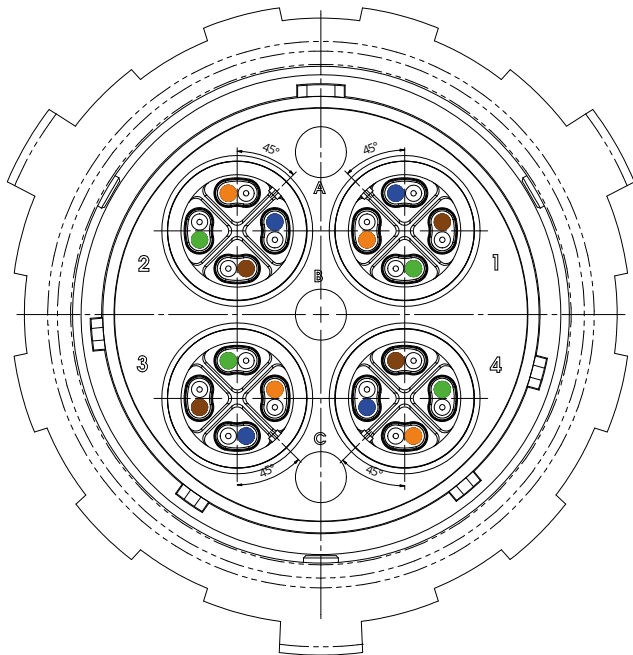

The connector can be completed with backshell and strain relief.

Receptacle with Pin Modules

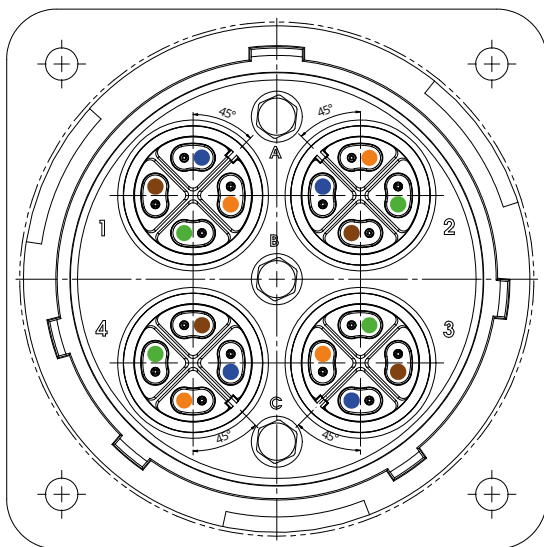

GMM Modules - 14Z8 Module

Ethernet Cat 6 - Ethernet Cat 5E

- 2x4 contact termination AWG 20
- High grade efficiency shielding for each module's EMI/RFI protection

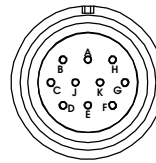

Socket insert

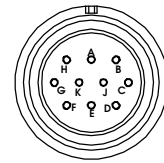

Pin insert

Module Type 1 for receptacle connectors (shell type 0 / 3, version 24A1, 40A4, 48A7)

Module Type 1 for plug connectors (shell type 6 / 8, version 24I1, 40I4, 48I7)

Part Number	Short Description	N° Poles	Ethernet	Contact Gender	Wire Section mm ²	AWG	Contact Type (size)	Contact plated
VS366135	GMM 1EII 14Z8P N04	2x4	Cat. 6	Pin	0,6	20	crimp	gold
VS366136	GMM 1GV 14Z8P N04	2x4	Cat. 5E	Pin	0,6	20	crimp	gold
VS366137*	GMM 1EII 14Z8S N04	2x4	Cat. 6	Socket	0,6	20	crimp	gold
VS366138*	GMM 1GV 14Z8S N04	2x4	Cat. 5E	Socket	0,6	20	crimp	gold

Module Type 6 for plug connectors (shell type 6 / 8, version 24A1, 40A4, 48A7)

Module Type 6 for receptacle connectors (shell type 0 / 3, version 24I1, 40I4, 48I7)

Part Number	Short Description	N° Poles	Ethernet	Contact Gender	Wire Section mm ²	AWG	Contact Type (size)	Contact plated
VS366139*	GMM 6EII 14Z8P N04	2x4	Cat. 6	Pin	0,6	20	crimp	gold
VS366140*	GMM 6GV 14Z8P N04	2x4	Cat. 5E	Pin	0,6	20	crimp	gold
VS366141	GMM 6EII 14Z8S N04	2x4	Cat. 6	Socket	0,6	20	crimp	gold
VS366142	GMM 6GV 14Z8S N04	2x4	Cat. 5E	Socket	0,6	20	crimp	gold

* on developing

Backshell Class	Backshell Class	Description
GV	GV	Adapter with shielding nut and cone for wire diameter 9,3mm (Ø 7,5 mm or Ø 10 mm on request)
EII	EII	Double spring adapter (strain relief & shielding) for cable Ø 7 ÷ Ø 10,1 mm

Materials and finishes:

Shell	Aluminum alloy – Electro-less nickel plated
Contacts	Copper alloy – Gold plating over Nickel
Insulator	Fire resisting rubber compound complies EN 45545-2 - NFPA 130 (ASTM E 162, ASTM E 662, BSS 7239)

GMM Modules - 14S2 Module

Ethernet Cat 5 - MVB - RS485 4 wire

- 4 contact termination
- High grade efficiency shielding for each module's EMI/RFI protection

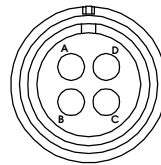

Socket insert

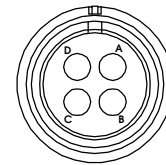

Pin insert

Module Type 1 for receptacle connectors (shell type 0 / 3, version 24A1, 40A4, 48A7)

Module Type 1 for plug connectors (shell type 6 / 8, version 24I1, 40I4, 48I7)

Part Number	Short Description	N° Poles	Rated Current	Rated Voltage	Contact Gender	Wire Section mm ²	AWG	Contact Type (size)	Contact plated
VS366143	GMM 1EII 14S2P N02	4	13A	200V	Pin	0,15±0,60	26 - 20	crimp	gold
VS366144	GMM 1GV 14S2P N02	4	13A	200V	Pin	0,15±0,60	26 - 20	crimp	gold
VS366145*	GMM 1EII 14S2S N02	4	13A	200V	Socket	0,15±0,60	26 - 20	crimp	gold
VS366146*	GMM 1GV 14S2S N02	4	13A	200V	Socket	0,15±0,60	26 - 20	crimp	gold
VS366237	GMM 1XE 14S2P A09 N02	4	13A	200V	Pin	0,15±0,60	26 - 20	crimp	gold

Module Type 6 for plug connectors (shell type 6 / 8, version 24A1, 40A4, 48A7)

Module Type 6 for receptacle connectors (shell type 0 / 3, version 24I1, 40I4, 48I7)

Part Number	Short Description	N° Poles	Rated Current	Rated Voltage	Contact Gender	Wire Section mm ²	AWG	Contact Type (size)	Contact plated
VS366147*	GMM 6EII 14S2P N02	4	13A	200V	Pin	0,15±0,60	26 - 20	crimp	gold
VS366148*	GMM 6GV 14S2P N02	4	13A	200V	Pin	0,15±0,60	26 - 20	crimp	gold
VS366149	GMM 6EII 14S2S N02	4	13A	200V	Socket	0,15±0,60	26 - 20	crimp	gold
VS366150	GMM 6GV 14S2S N02	4	13A	200V	Socket	0,15±0,60	26 - 20	crimp	gold
VS366238	GMM 6XE 14S2S A09 N02	4	13A	200V	Socket	0,15±0,60	26 - 20	crimp	gold

* on developing

Terminations for other section can be supplied on request

GV	GV	Adapter with shielding nut and cone for wire diameter 9,3mm (Ø 7,5 mm or Ø 10 mm on request)
EII	Backshell Class	EII Double spring adapter (strain relief & shielding) for cable Ø 7 ÷ Ø 10,1 mm
XE...	XE...A09	Adapter for crimping sleeve and heat shrink tube for cables up to Ø 9 mm (Ø 5 mm or Ø 6 mm on request)

Materials and finishes:

Shell	Aluminum alloy – Electro-less nickel plated
Contacts	Copper alloy – Gold plating over Nickel
Insulator	Fire resisting rubber compound complies EN 45545-2 - NFPA 130 (ASTM E 162, ASTM E 662, BSS 7239)

GMM Modules - 14S9 Module

WTB

- 2 contact termination AWG 20
- High grade efficiency shielding for each module's EMI/RFI protection
- Service rating A = Operating Voltage (AC) 500Vac – (DC) 700Vcc

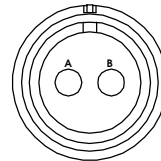

Socket insert

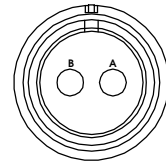

Pin insert

Module Type 1 for receptacle connectors (shell type 0 / 3, version 24A1, 40A4, 48A7)

Module Type 1 for plug connectors (shell type 6 / 8, version 24I1, 40I4, 48I7)

Part Number	Short Description	N° Poles	Rated Current	Rated Voltage	Contact Gender	Wire Section mm ²	AWG	Contact Type (size)	Contact plated
VS366151	GMM 1A 14S9P N02	2	13A	500Vca	Pin	0,15±0,6	26 - 20	crimp	gold
VS366152	GMM 1GV 14S9P N02	2	13A	500Vca	Pin	0,15±0,6	26 - 20	crimp	gold
VS366153	GMM 1XE 14S9P A09 N02	2	13A	500Vca	Pin	0,15±0,6	26 - 20	crimp	gold
VS366154*	GMM 1A 14S9S N02	2	13A	500Vca	Socket	0,15±0,6	26 - 20	crimp	gold
VS366155*	GMM 1GV 14S9S N02	2	13A	500Vca	Socket	0,15±0,6	26 - 20	crimp	gold
VS366156*	GMM 1XE 14S9S A09 N02	2	13A	500Vca	Socket	0,15±0,6	26 - 20	crimp	gold

Module Type 6 for plug connectors (shell type 6 / 8, version 24A1, 40A4, 48A7)

Module Type 6 for receptacle connectors (shell type 0 / 3, version 24I1, 40I4, 48I7)

Part Number	Short Description	N° Poles	Rated Current	Rated Voltage	Contact Gender	Wire Section mm ²	AWG	Contact Type (size)	Contact plated
VS366157*	GMM 6A 14S9P N02	2	13A	500Vca	Pin	0,15±0,6	26 - 20	crimp	gold
VS366158*	GMM 6GV 14S9P N02	2	13A	500Vca	Pin	0,15±0,6	26 - 20	crimp	gold
VS366159*	GMM 6XE 14S9P A09 N02	2	13A	500Vca	Pin	0,15±0,6	26 - 20	crimp	gold
VS366160	GMM 6A 14S9S N02	2	13A	500Vca	Socket	0,15±0,6	26 - 20	crimp	gold
VS366161	GMM 6GV 14S9S N02	2	13A	500Vca	Socket	0,15±0,6	26 - 20	crimp	gold
VS366162	GMM 6XE 14S9S A09 N02	2	13A	500Vca	Socket	0,15±0,6	26 - 20	crimp	gold

* on developing

Terminations for other section can be supplied on request

GV	GV	Adapter with shielding nut and cone for wire diameter 9,3mm (Ø 7,5 mm or Ø 10 mm on request)
A	Backshell Class A	Short backshell (the module is supplied without EMI grounding finger)
XE...	XE...A09	Adapter for crimping sleeve and heat shrink tube for cables up to Ø 9 mm (Ø 5 mm or Ø 6 mm on request)

Materials and finishes:

Shell	Aluminum alloy – Electro-less nickel plated
Contacts	Copper alloy – Gold plating over Nickel
Insulator	Fire resisting rubber compound complies EN 45545-2 - NFPA 130 (ASTM E 162, ASTM E 662, BSS 7239)

GMM Modules - FO Optical Module

FO3 SC connectors - FOB Expanded Beam connectors

- 3 SC connectors
- Expanded Beam connectors, Single Mode (SM) / Multimode (MM) 2 Channel or 4 Channel

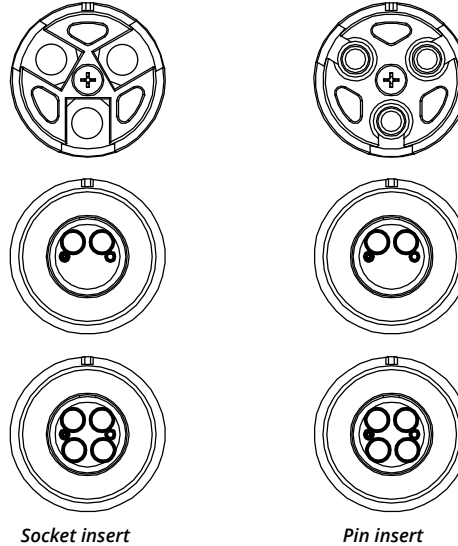

Module Type 1 for receptacle connectors (shell type 0 / 3, version 24A1, 40A4, 48A7)
Module Type 1 for plug connectors (shell type 6 / 8, version 24I1, 40I4, 48I7)

Part Number	Short Description	N° Poles	Module for connectors type	Channel	Mode
VS366163	GMM 1 FOSC3P LC	3	SC connectors**	-	-

*** SC Connectors to be purchased separately*

Module Type 6 for plug connectors (shell type 6 / 8, version 24A1, 40A4, 48A7)
Module Type 6 for receptacle connectors (shell type 0 / 3, version 24I1, 40I4, 48I7)

Part Number	Short Description	N° Poles	Module for connectors type	Channel	Mode
VS366168	GMM 6 FOSC3S LC	3	SC connectors**	-	-

*** SC Connectors to be purchased separately*

Materials and finishes:

Shell Thermoplastic shell
 Insulator Thermoplastic fire resisting complies EN 45545-2 - NFPA 130 (ASTM E 162, ASTM E 662, BSS 7239)

GMM Modules - C Coax Module

C8 for CC485-8 contacts - C4 for CC485-4 contacts - C4R for CC RP contacts

- Size 8 used with wire RG58 / RG59 / RG179 / RG187
- Size 4 for RG59
- Size 4 for Wi-Fi 2.4GHz & 5 GHz / GSMR / GPS / WLAN
- C Coax Module is supplied without contacts

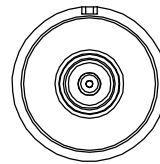

Socket insert

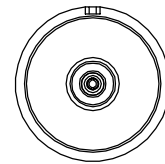

Pin insert

Module Type 1 for receptacle connectors (shell type 0 / 3, version 24A1, 40A4, 48A7)

Module Type 1 for plug connectors (shell type 6 / 8, version 24I1, 40I4, 48I7)

Part Number	Short Description	N° Poles	Module for connectors type
VS366173*	GMM 1 C8S LC	1	RG58 / RG59 / RG179 / RG187
VS366174*	GMM 1 C4S LC	1	RG59
VS366175*	GMM 1 C4RS LC	1	Wi-Fi 2.4GHz & 5 GHz / GSMR / GPS / WLAN

* on developing

Consult our Commercial Office for Coaxial Contacts

Module Type 6 for plug connectors (shell type 6 / 8, version 24A1, 40A4, 48A7)

Module Type 6 for receptacle connectors (shell type 0 / 3, version 24I1, 40I4, 48I7)

Part Number	Short Description	N° Poles	Module for connectors type
VS366176*	GMM 6 C8P LC	1	RG58 / RG59 / RG179 / RG187
VS366177*	GMM 6 C4P LC	1	RG59
VS366178*	GMM 6 C4RP LC	1	Wi-Fi 2.4GHz & 5 GHz / GSMR / GPS / WLAN

* on developing

Consult our Commercial Office for Coaxial Contacts

Materials and finishes:

Shell Thermoplastic shell
 Insulator Thermoplastic fire resisting complies EN 45545-2 - NFPA 130 (ASTM E 162, ASTM E 662, BSS 7239)

GMM Modules - P Power Module

Contacts size 8 - for contacts size 4

- 1 pole
- Thermoplastic shell

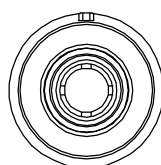

Socket insert

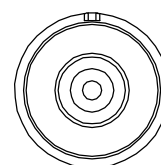

Pin insert

Module Type 1 for receptacle connectors (shell type 0 / 3, version 24A1, 40A4, 48A7)

Module Type 1 for plug connectors (shell type 6 / 8, version 24I1, 40I4, 48I7)

Part Number	Short Description	N° Poles	Rated Current	Rated Voltage	Contact Gender	Wire Section mm ²	AWG	Contact Type (size)	Contact plated
VS366179*	GMM 1 P4P N06	1	80A	900V	Pin	22	4	crimp (4)	silver
VS366180*	GMM 1 P8P N07	1	46A	1.250V	Pin	6	10	crimp (8)	silver
VS366181*	GMM 1 P4S N06	1	80A	900V	Socket	22	4	crimp (4)	silver
VS366182*	GMM 1 P8S N07	1	46A	1.250V	Socket	6	10	crimp (8)	silver

* on developing

Terminations for other section can be supplied on request

Module Type 6 for plug connectors (shell type 6 / 8, version 24A1, 40A4, 48A7)

Module Type 6 for receptacle connectors (shell type 0 / 3, version 24I1, 40I4, 48I7)

Part Number	Short Description	N° Poles	Rated Current	Rated Voltage	Contact Gender	Wire Section mm ²	AWG	Contact Type (size)	Contact plated
VS366183*	GMM 6 P4P N06	1	80A	900V	Pin	22	4	crimp (4)	silver
VS366184*	GMM 6 P8P N07	1	46A	1.250V	Pin	6	10	crimp (8)	silver
VS366185*	GMM 6 P4S N06	1	80A	900V	Socket	22	4	crimp (4)	silver
VS366186*	GMM 6 P8S N07	1	46A	1.250V	Socket	6	10	crimp (8)	silver

* on developing

Terminations for other section can be supplied on request

Materials and finishes:

Shell Thermoplastic shell
 Contacts Copper alloy – Silver plating over Nickel (Gold plating available on request)
 Insulator Thermoplastic fire resisting complies EN 45545-2 - NFPA 130 (ASTM E 162, ASTM E 662, BSS 7239)

GMM Modules - 13P3 Power Module

With Ground Contact

- 2 poles + ground contact
- Equipped with first-mate last-break (FMLB) Pin grounding contact
- Service rating I = Operating Voltage (AC) 200 Vac – (DC) 250 Vcc

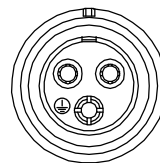

Socket insert

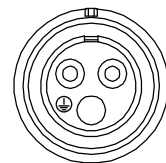

Pin insert

Module Type 1 for receptacle connectors (shell type 0 / 3, version 24A1, 40A4, 48A7)

Module Type 1 for plug connectors (shell type 6 / 8, version 24I1, 40I4, 48I7)

Part Number	Short Description	N° Poles	Rated Current	Rated Voltage	Contact Gender	Wire Section mm ²	AWG	Contact Type (size)	Contact plated
VS366231	GMM 1A 13P3P N05	2+PE	13A	200Vca	Pin	2,5	-	crimp	silver
VS366188	GMM 1EII 13P3P N05	2+PE	13A	200Vca	Pin	2,5	-	crimp	silver
VS366189*	GMM 1A 13P3S N05	2+PE	13A	200Vca	Socket	2,5	-	crimp	silver
VS366190*	GMM 1EII 13P3S N05	2+PE	13A	200Vca	Socket	2,5	-	crimp	silver

* on developing

Terminations for other section can be supplied on request

Module Type 6 for plug connectors (shell type 6 / 8, version 24A1, 40A4, 48A7)

Module Type 6 for receptacle connectors (shell type 0 / 3, version 24I1, 40I4, 48I7)

Part Number	Short Description	N° Poles	Rated Current	Rated Voltage	Contact Gender	Wire Section mm ²	AWG	Contact Type (size)	Contact plated
VS366191*	GMM 6A 13P3P N05	2+PE	13A	200Vca	Pin	2,5	-	crimp	silver
VS366192*	GMM 6EII 13P3P N05	2+PE	13A	200Vca	Pin	2,5	-	crimp	silver
VS366232	GMM 6A 13P3S N05	2+PE	13A	200Vca	Socket	2,5	-	crimp	silver
VS366194	GMM 6EII 13P3S N05	2+PE	13A	200Vca	Socket	2,5	-	crimp	silver

* on developing

Terminations for other section can be supplied on request

Backshell Class	Description
A	Short backshell (the module is supplied without EMI grounding finger)
EII	Double spring adapter (strain relief & shielding) for cable Ø 7 ÷ Ø 10,1 mm

Materials and finishes:

Shell	Aluminum alloy – Electro-less nickel plated
Contacts	Copper alloy – Silver plating over Nickel (Gold plating available on request)
Insulator	Fire resisting rubber compound complies EN 45545-2 - NFPA 130 (ASTM E 162, ASTM E 662, BSS 7239)

GMM Modules - Multifunctional Modules

13A – contact size 16

- Up to 7 poles
- High grade efficiency shielding for each module's EMI/RFI protection
- XA = Adapter for heat shrink tube for wire diameter 10,2mm

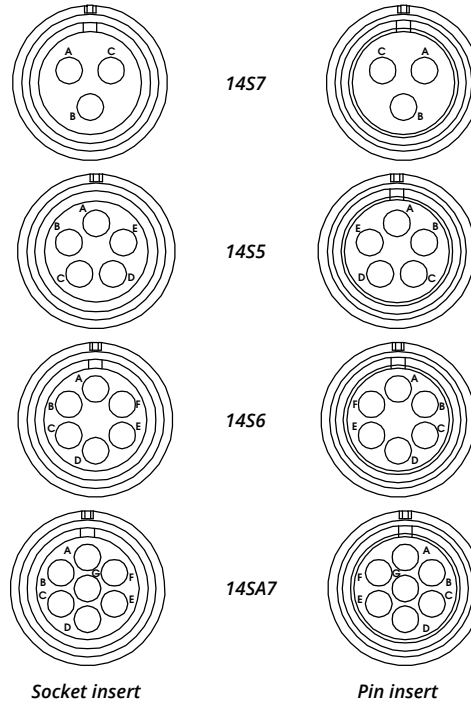

Module Type 1 for receptacle connectors (shell type 0 / 3, version 24A1, 40A4, 48A7)

Module Type 1 for plug connectors (shell type 6 / 8, version 24I1, 40I4, 48I7)

Part Number	Short Description	N° Poles	Rated Current	Rated Voltage	Contact Gender	Wire Section mm ²	AWG	Contact Type (size)	Contact plated
VS366195	GMM 1XA 14S7P N01	3	13A	500V	Pin	1,00÷1,50	18 - 16	crimp	gold
VS366196	GMM 1XA 14S5P N01	5	13A	200V	Pin	1,00÷1,50	18 - 16	crimp	gold
VS366197	GMM 1XA 14S6P N02	6	13A	200V	Pin	0,15÷0,60	26 - 20	crimp	gold
VS366198	GMM 1XA 14SA7P N02	7	13A	200V	Pin	0,15÷0,60	26 - 20	crimp	gold
VS366199*	GMM 1XA 14S7S N01	3	13A	500V	Socket	1,00÷1,50	18 - 16	crimp	gold
VS366200*	GMM 1XA 14S5S N01	5	13A	200V	Socket	1,00÷1,50	18 - 16	crimp	gold
VS366201*	GMM 1XA 14S6S N02	6	13A	200V	Socket	0,15÷0,60	26 - 20	crimp	gold
VS366202*	GMM 1XA 14SA7S N02	7	13A	200V	Socket	0,15÷0,60	26 - 20	crimp	gold

* on developing

Terminations for other section can be supplied on request

Module Type 6 for plug connectors (shell type 6 / 8, version 24A1, 40A4, 48A7)

Module Type 6 for receptacle connectors (shell type 0 / 3, version 24I1, 40I4, 48I7)

Part Number	Short Description	N° Poles	Rated Current	Rated Voltage	Contact Gender	Wire Section mm ²	AWG	Contact Type (size)	Contact plated
VS366203*	GMM 6XA 14S7P N01	3	13A	500V	Pin	1,00÷1,50	18 - 16	crimp	gold
VS366204*	GMM 6XA 14S5P N01	5	13A	200V	Pin	1,00÷1,50	18 - 16	crimp	gold
VS366205*	GMM 6XA 14S6P N02	6	13A	200V	Pin	0,15÷0,60	26 - 20	crimp	gold
VS366206*	GMM 6XA 14SA7P N02	7	13A	200V	Pin	0,15÷0,60	26 - 20	crimp	gold
VS366207	GMM 6XA 14S7S N01	3	13A	500V	Socket	1,00÷1,50	18 - 16	crimp	gold
VS366208	GMM 6XA 14S5S N01	5	13A	200V	Socket	1,00÷1,50	18 - 16	crimp	gold
VS366209	GMM 6XA 14S6S N02	6	13A	200V	Socket	0,15÷0,60	26 - 20	crimp	gold
VS366210	GMM 6XA 14SA7S N02	7	13A	200V	Socket	0,15÷0,60	26 - 20	crimp	gold

* on developing

Terminations for other section can be supplied on request

Materials and finishes:

Shell Aluminum alloy – Electro-less nickel plated
 Contacts Copper alloy – Gold plating over Nickel (Silver plating available on request)
 Insulator Fire resisting rubber compound complies EN 45545-2 - NFPA 130 (ASTM E 162, ASTM E 662, BSS 7239)

GMM Modules - Multifunctional Modules

7,5A - contact size 20

- Up to 14 poles
- High grade efficiency shielding for each module's EMI/RFI protection
- XE ... A09 Adapter for crimping sleeve and heat shrink tube for cables up to Ø 9mm (Ø 5mm - Ø 6mm on request)
- A = short backshell

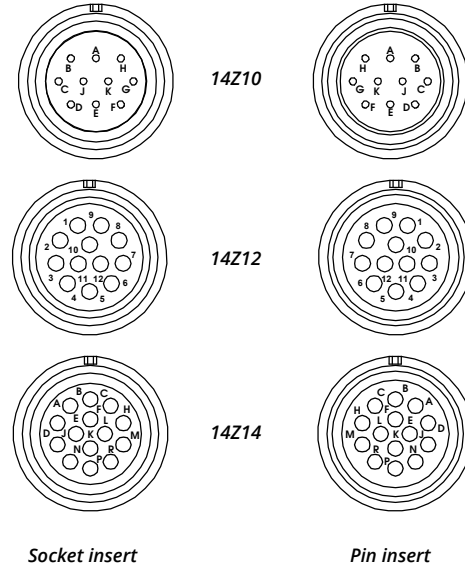

Module Type 1 for receptacle connectors (shell type 0 / 3, version 24A1, 40A4, 48A7)

Module Type 1 for plug connectors (shell type 6 / 8, version 2411, 4014, 4817)

Part Number	Short Description	N° Poles	Rated Current	Rated Voltage	Contact Gender	Wire Section mm ²	AWG	Contact Type (size)	Contact plated
VS366211	GMM 1XE 14Z10P A09 N04	10	7,5A	200V	Pin	0,6	20	crimp	gold
VS366212	GMM 1XE 14Z12P A09 N04	12	7,5A	200V	Pin	0,6	20	crimp	gold
VS366213	GMM 1A 14Z14P N04	14	7,5A	200V	Pin	0,6	20	crimp	gold
VS366214	GMM 1XE 14Z14P A09 N04	14	7,5A	200V	Pin	0,6	20	crimp	gold
VS366215*	GMM 1XE 14Z10S A09 N04	10	7,5A	200V	Socket	0,6	20	crimp	gold
VS366216*	GMM 1XE 14Z12S A09 N04	12	7,5A	200V	Socket	0,6	20	crimp	gold
VS366217*	GMM 1A 14Z14S N04	14	7,5A	200V	Socket	0,6	20	crimp	gold
VS366218*	GMM 1XE 14Z14S A09 N04	14	7,5A	200V	Socket	0,6	20	crimp	gold

* on developing

Terminations for other section can be supplied on request

Module Type 6 for plug connectors (shell type 6 / 8, version 24A1, 40A4, 48A7)

Module Type 6 for receptacle connectors (shell type 0 / 3, version 2411, 4014, 4817)

Part Number	Short Description	N° Poles	Rated Current	Rated Voltage	Contact Gender	Wire Section mm ²	AWG	Contact Type (size)	Contact plated
VS366219*	GMM 6XE 14Z10P A09 N04	10	7,5A	200V	Pin	0,6	20	crimp	gold
VS366220*	GMM 6XE 14Z12P A09 N04	12	7,5A	200V	Pin	0,6	20	crimp	gold
VS366221*	GMM 6A 14Z14P N04	14	7,5A	200V	Pin	0,6	20	crimp	gold
VS366222*	GMM 6XE 14Z14P A09 N04	14	7,5A	200V	Pin	0,6	20	crimp	gold
VS366223	GMM 6XE 14Z10S A09 N04	10	7,5A	200V	Socket	0,6	20	crimp	gold
VS366224	GMM 6XE 14Z12S A09 N04	12	7,5A	200V	Socket	0,6	20	crimp	gold
VS366225	GMM 6A 14Z14S N04	14	7,5A	200V	Socket	0,6	20	crimp	gold
VS366226	GMM 6XE 14Z14S A09 N04	14	7,5A	200V	Socket	0,6	20	crimp	gold

* on developing

Terminations for other section can be supplied on request

Materials and finishes:

Shell	Aluminum alloy - Electro-less nickel plated
Contacts	Copper alloy - Gold plating over Nickel (Silver plating available on request)
Insulator	Fire resisting rubber compound complies EN 45545-2 - NFPA 130 (ASTM E 162, ASTM E 662, BSS 7239)

GM Connector - Accessories



Dummy modules

Dummy modules

Part Number	Short Description	Dummy Modules
VS366229	GMM 614	For plug module cavity - sealed
VS366230	GMM 114	For receptacle module cavity - sealed
VS366267	GMM-FILL-PS	For receptacle and plug module cavity



Module removal tool

Module removal tool

Part Number	Short Description	Tools
VS366243	GMM RT	Module extraction tool for cable up to Ø 15mm
VS366248	GMM RT10	Module extraction tool for cable up to Ø 10mm
VS366244	GMM RTP-14*	Module extraction protection for modules 14S and 14Z
VS366245	GMM RTP-C7*	Module extraction protection for modules C7

** must be used with GMM-RT*

GMM Modules - Backshell class

GMM 6 XE 14Z10 P A09 N04

A

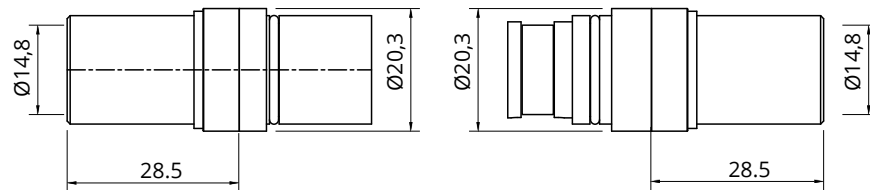

XA

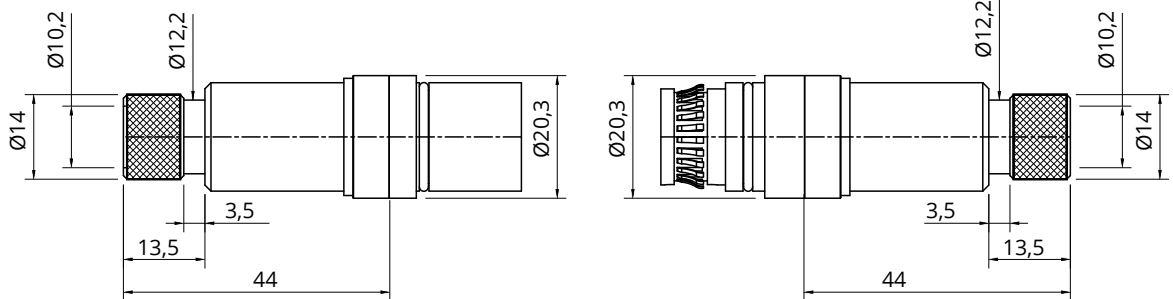

GV

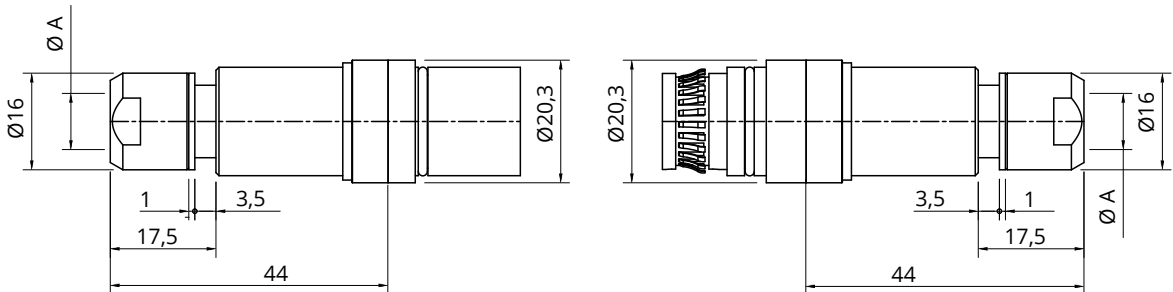

XE

Backshell Class

A	Short backshell (the module is supplied without EMI grounding finger)
XA	Adapter for heat shrink tube for wire diameter 10,2mm
GV	Adapter with shielding nut and cone for wire diameter 9,3mm
XE..	Adapter for crimping sleeve and heat shrink tube
EII	Double spring adapter (strain relief & shielding) for cable Ø 7 ÷ Ø 10,1 mm
-	Without Backshell

GV..

Backshell Class

		Ø A
GV	GV Module for cables up to Ø 9,3mm	9,3
GV..A07	GV Module for cables up to Ø 7,5mm	7,5
GV..A10	GV Module for cables up to Ø10mm	10
GV..A13	GV Module for cables up to Ø13.5mm	13.5

GMM Modules - Backshell class

- GMM
- 6
- XE
- 14Z10
- P
- A09
- N04
-

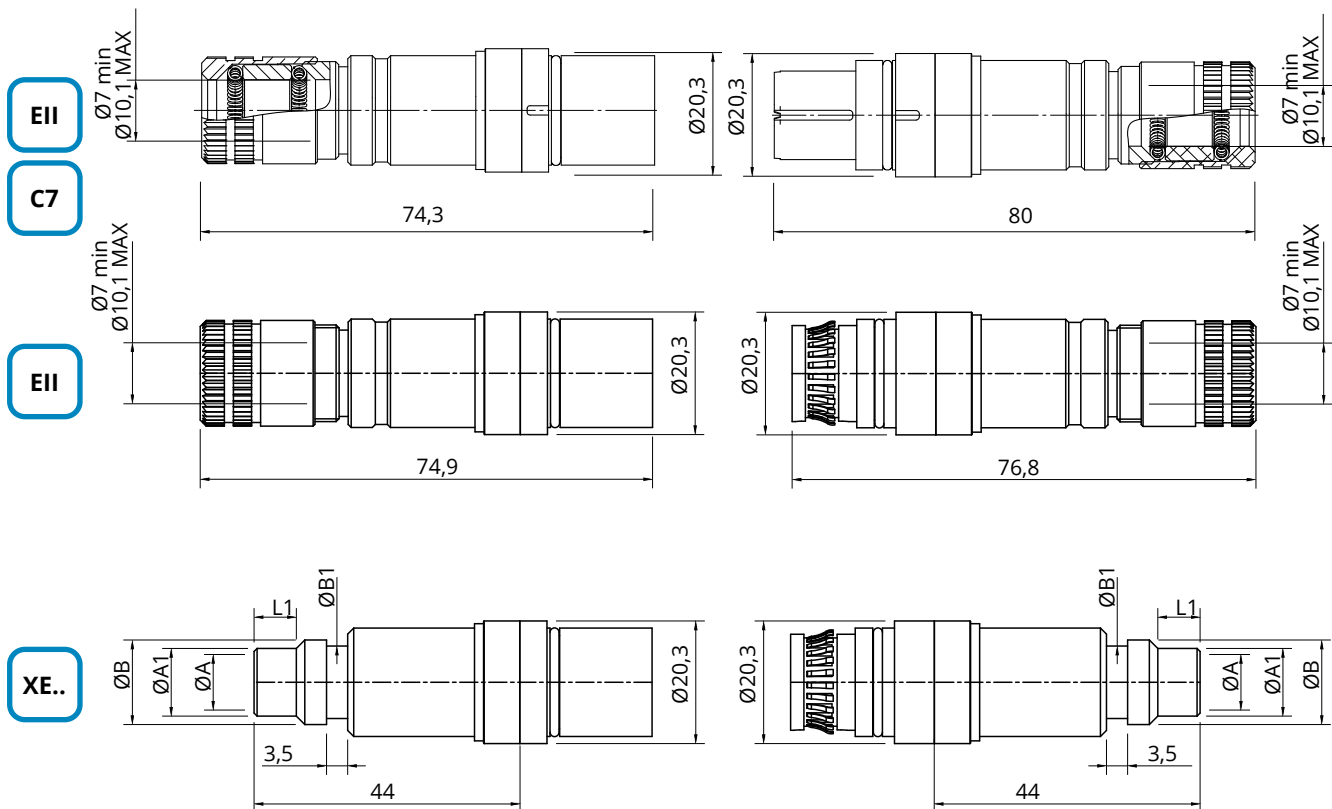

			$\varnothing A$	$\varnothing A1$	$\varnothing B$	$\varnothing B1$	$L1$	
XE..	Backshell Class	XE..A05	XE Module for cables up to $\varnothing 5$ mm	5.2	7.8	11	9	8
		XE..A06	XE Module for cables up to $\varnothing 6$ mm	6.2	7.8	11	9	8
		XE..A09	XE Module for cables up to $\varnothing 9$ mm	9.2	11.2	14	12	7
		XE..A11	XE Module for cables up to $\varnothing 11$ mm	11	13	16	14	8

GM Connector - Accessories



Internal Strain Alignment Disc for backshell Class SMxx, SPxx

Size	Short Description	Ø Max
40	Internal Strain Alignment Disc	9,7mm
48	Internal Strain Alignment Disc	*

* on developing



Internal Cable Relief backshell Class RLMxx, RLPxx

Size	Short Description	Ø
40	Internal Cable Relief	5 ÷ 9

GM Connector - Accessories

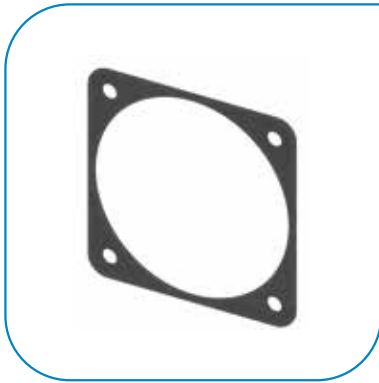

Panel Gasket

Gaskets

These gaskets are used to make panel connectors water resistant.

Gaskets for front mounting panel connectors (0 connectors):

- gasket C215: non conductive chloroprene rubber gasket (IP67 protection)
- gasket C215R: conductive chloroprene rubber gasket with embedded metal screen (IP65 protection).
These gaskets guarantee watertightness and RFI shielding

Part Number	Short Description	Panel Gasket
VS412307	C215-24	non-conductive (0)
VS412357	C215R-24	conductive (0)
VS412315	C215-40	non-conductive (0)
VS412361	C215R-40	conductive (0)

Gaskets for rear mounting panel connectors (3 connectors):

- gasket C216: non conductive chloroprene rubber gasket (IP67 protection)
- gasket C216R: conductive chloroprene rubber gasket with embedded metal screen (IP65 protection).
These gaskets guarantee watertightness and RFI shielding

Part Number	Short Description	Panel Gasket
VS412407	C216-24	non-conductive (3)
VS412457	C216R-24	conductive (3)
VS412411	C216-40	non-conductive (3)
VS412461	C216R-40	conductive (3)

Protective Plastic Dust Caps

These caps are used to protect connectors against dust. They are not included in the connectors and have to be ordered separately.

The drawings are indicative only and they could be change according to the size

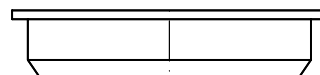
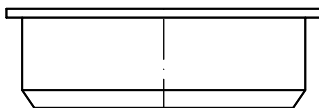

Caps for connectors version: shell type with ramp

Shell size	Part Number	Short Description
24	on request	PGM 043-24
40	on request	PGM 043-40
48	on request	PGM 043-48

Caps for connector version: shell type with rubber covered coupling nut

Shell size	Part Number	Short Description
24	on request	PGM 042-24
40	on request	PGM 042-40
48	on request	PGM 042-48

GM Connector - Grommet

Internal Grommet for Backshell Class RM

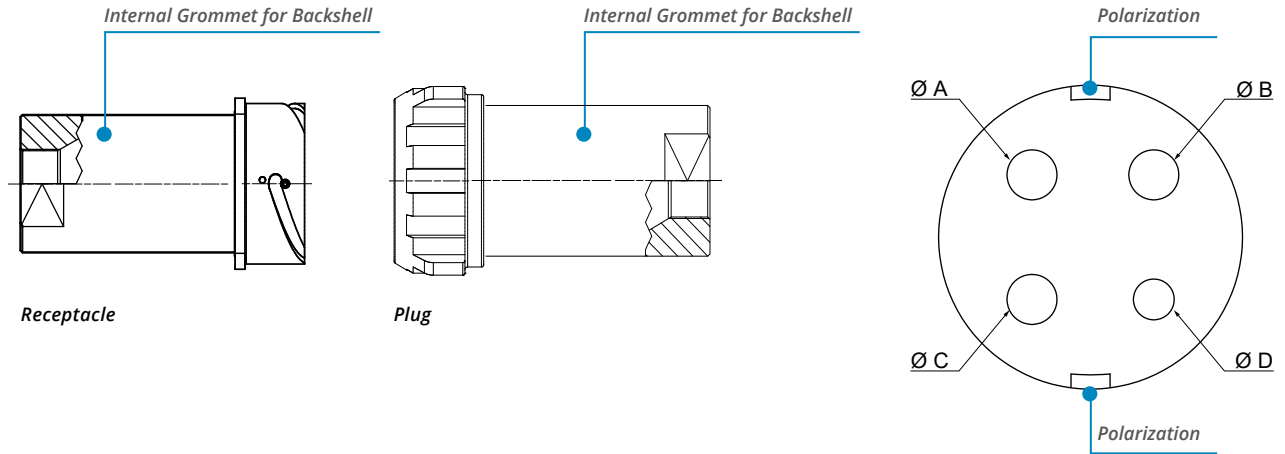

Order Number	Short Description	Connector Size*	Ø A	Ø B	Ø C	Ø D
on request	GM GRM R01A **	40	8.5	8	9.2	6.5
on request	GM GRM R01B **	40	8	8.5	6.5	9.2
on request	GM GRM R02A **	40	8.5	6.5	9.2	6.5
on request	GM GRM R02B **	40	6.5	8.5	6.5	9.2
on request	GM GRM R05	40	8.5	8.5	9.2	9.2
on request	GM GRM R15	6.5	6.5	6.5	6.5	6.5
on request	GM GRM R16A **	6.5	6.5	6.5	8	6.5
on request	GM GRM R16B **	6.5	6.5	6.5	6.5	8

** To be used A version in the Receptacle and B version in the Plug (or viceversa)

* Others available on request

Hole Plugs for Grommet

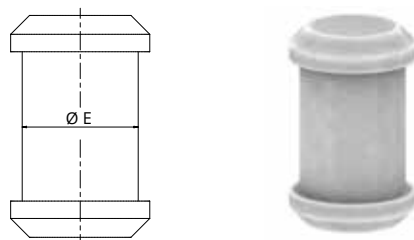

Order Number	Short Description	Ø E
on request	GM HP 65 G	6.5
on request	GM HP 80 G	8
on request	GM HP 85 G	8.5
on request	GM HP 92 G	9.2

GM Connector - Grommet

Grommet for Cable Adapter Backshell Class RPMxx, RPxx, SMxx, SPxx, RLMxx, RLPxx, RPF

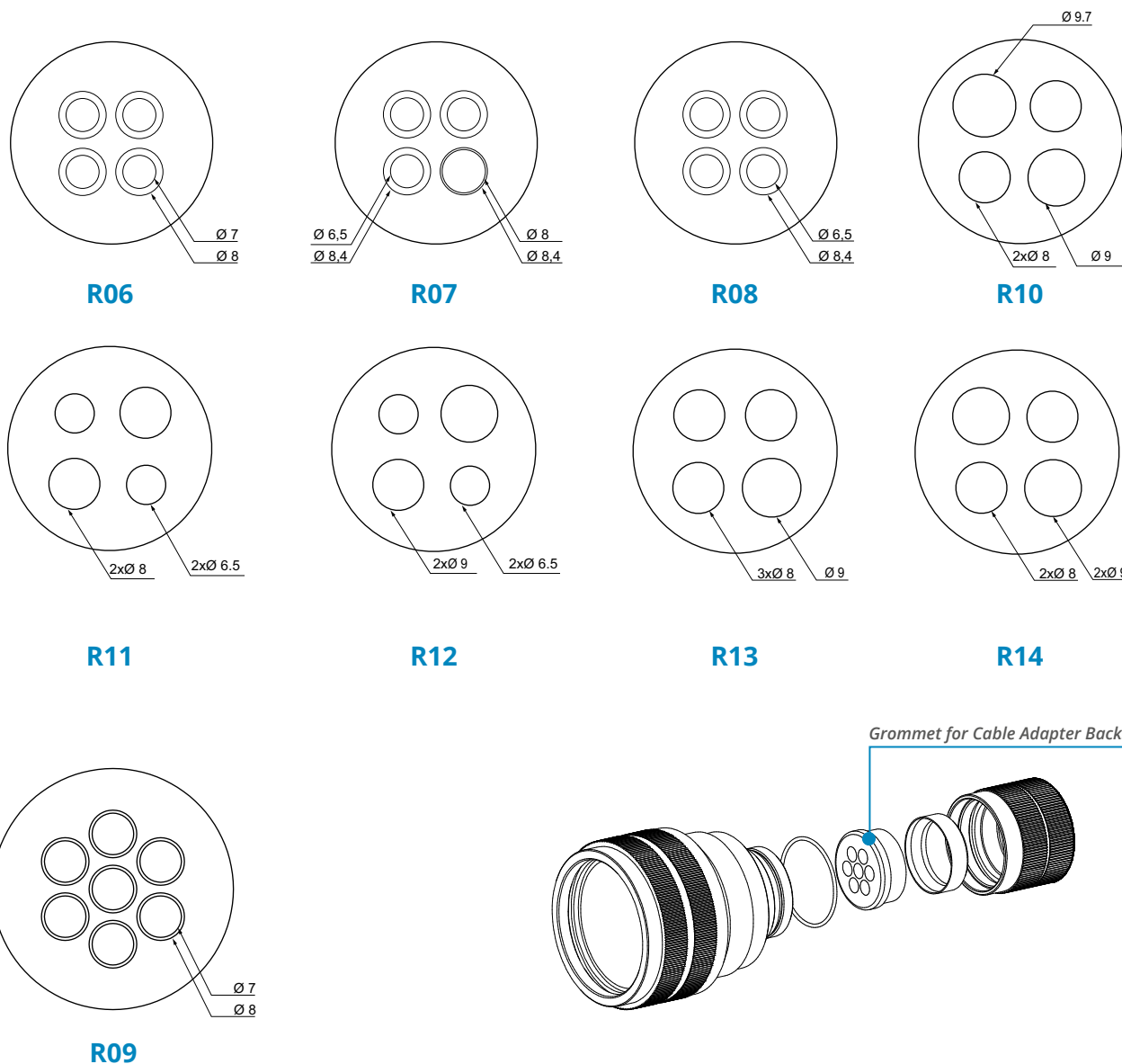



Order Number	Short Description	Cable Adapter Size	Connector Size
on request	GM GRCA R06	M32	40
on request	GM GRCA R07	M32	40
on request	GM GRCA R08	M32	40
on request	GM GRCA R10	M32	40
on request	GM GRCA R11	M32	40
on request	GM GRCA R12	M32	40
on request	GM GRCA R13	M32	40
on request	GM GRCA R14	M32	40
on request	GM GRCA R09	M40	48

GM Connector - Mechanical coding Accessories



Mechanical coding accessories

Part Number	Short Description	Coding pins
VS366227	GMM 42	Threaded column 
VS366228	GMM 43	Hole cap 



Polarization

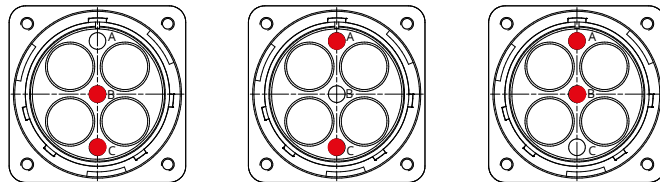

Size 40 and module number A4/I4

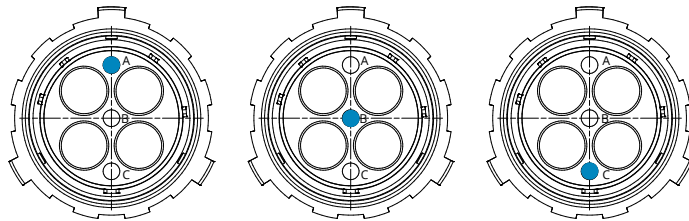

Size 40 and module n° A4/I4

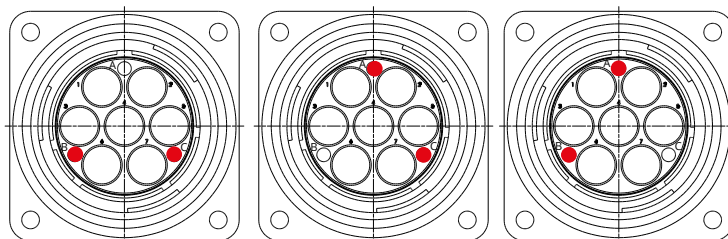

Size 48 and module number A7/I7

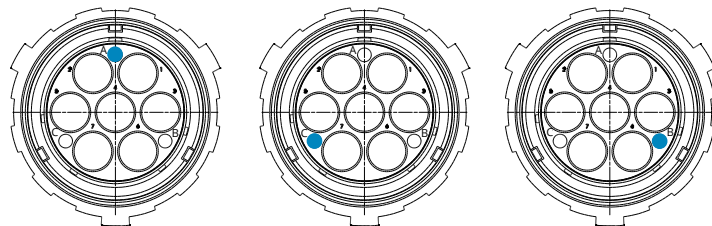

Size 48 and module n° A7/I7

GMM Modules - Spare Parts



Contacts pair Cat. 7A - C7 module

Part Number	Short Description	Gender
VS366241	GMM CP-S- C7	Socket
VS366242	GMM CP-P-C7	Pin



Protection Cap - C7 module

Part Number	Short Description	Type
VS366239	GMM TP-S-C7	For Socket module
VS366240	GMM TP-P-C7	For Pin module

GMM Modules - Crimping Tools

For the instructions concerning the contacts crimping please consult the tools manuals.

We recommend to respect the following general rules:

- always use the tools recommended by Radiall VanSystem's in the catalogue or manuals
- apply the suggested norms for tool maintenance and calibration

Do not use alternative greases or oils which could damage the insert and affect the functionality of the connector.



Modules type	Module extraction tool	Module extraction protection	Contacts insertion tool	Contacts extraction tool	Socket contacts guide pin	Contacts crimping tool	Locator	Wire stripping tool
14S9/2/5/7/A7	GMM RT	GMM RTP-14	CTIN-784-16	CTES-784-16	GP-784-16	CRT-784/1	LOC-784	-
14Z8	GMM RT	GMM RTP-14	CTIN-784-18/20	CTES-784-20	-	CRT-CT-784	LOC-CT-784	-
14Z10/12/14	GMM RT	GMM RTP-14	CTIN-784-18/20	CTES-784-20	-	CRT-CT-784	LOC-CT-784	-
C7 *	GMM RT	GMM RTP-C7	-	-	-	CRT-C7	-	GMM ST-C7
P4	GMM RT	-	**	**	-	**	-	-
P8	GMM RT	-	**	**	-	**	-	-
13P3	GMM RT	-	**	**	**	**	**	-
C4 - C8	GMM RT	-	**	**	-	**	-	-

* For a faster wire identification & easier assembly we suggest to add GMM WI-C7 to the C7 standard tool kit

** Consult factory for suitable tool and assembly instructions

Part Number	Short Description	Tool
VS610002	CRT-784/1	Crimping Tool Daniels DMC VM8
VS610008	LOC-784	Locator (for ST485 contacts size 16 and 12) Daniels TURRET VH435-1
VS610019	CTIN-784-18/20	Insertion Tool (for ST485 contacts size 18, 20 and 16-13)
VS610020	CTIN-784-16	Insertion Tool (for ST485 contacts size 16)
VS610030	CTES-784-20	Removal Tool (for ST485 contacts size 20)
VS610032	CTES-784-16	Removal Tool (for ST485 contacts size 16)
VS610054	GP-784-16	Guide Pin Size 16
VS610057	CRT-C7	Crimping Tool Cat.7 contacts pair
VS610058	GMM ST-C7	Wire Stripping Tool Weidmuller Stripax 0,08mm ² - 10mm ² (28 AWG - 8 AWG)
VS610067	CRT-CT-784	Crimping Tool (M22520/2-01) Daniels DMC AFM8
VS610068	LOC-CT-784	Locator (for CT 485 contacts/ Daniels DMC K1S (M22520/2-02)
VS366243	GMM RT	Removal Tool for cable up to Ø 15mm
VS366244	GMM RTP-14	Module Extraction Protection 145-147
VS366245	GMM RTP-C7	Module Extraction Protection C7
Part Number	Short Description	Tool
VS610069	CRT-SH30L	Manual Crimp Tool for Shielding
VS610070	CDI-30K06	Crimp Die for Shielding Sleeve Ø 6mm
VS610071	CDI-30K09	Crimp Die for Shielding Sleeve Ø 9mm

Safety

Information regarding the use of the product within recommended safety limits

To use the connectors described in this catalogue according to the necessary safety requirements we suggest you apply the following criteria:

- use the connectors and connected cables within their electrical and environmental limits
- follow the characteristics of each version (shell, class and type of strain relief) and carefully choose the appropriate connector for the required use
- make sure to respect the procedures regarding the correct assembly of connectors and the crimping of contacts
- any connector damaged during shipment, storage, assembly or use should be replaced
- never uncouple the connectors when under power
- always protect the parts against shock when the circuit is under power
- always check the circuit before putting it under power
- consult Radiall Italia Srl if in doubt
- the user must take final responsibility for electrical safety Radiall Italia Srl reserves the right to amend the specifications of this catalogue without issuing prior notice.

For the instructions concerning assembly and crimping of contacts please consult the appropriate tools manuals.

We recommend to respect the following general rules:

- to be used always the tools recommended by Radiall Italia Srl's catalogue or manuals
- to be applied the suggested norms for tool maintenance and calibration

DO NOT USE ALTERNATIVE GREASES OR OILS which could damage the insert and affect the functionality of the connector. Radiall Italia Srl reserves the right to amend the specifications of this catalogue without issuing prior notice.

The data defined in this document are given as an indication. In the effort to improve our products, we reserve the right to make any change judged necessary.



www.radiall.com

FRANCE

RADIALL S.A.
Tel +33149353535
info@radiall.com



www.vansystem.eu

ITALY

Radiall Italia S.r.l.
Tel. +39023569931
infoit@radiall.com

2024 EDITION
02.2024

050.GM018
PRINTED IN ITALY