



SPPC/S-BOX

CATALOG

SINGLE POLE POWER CONNECTORS SPPC-PWL-2.0/PWL/SB/HK/LJP
For Industrial applications



Radiall 

 **VanSystem**

About Us



Radiall

Radiall has been enabling technology and innovation through collaboration with customers since 1952.

This has resulted in a range of innovative and award-winning products that customers trust for unrivaled repeatability and performance. Radiall's success is built on strong customer relationships and quality components, which have been established since its foundation.

With a focus on simplification and innovation, Radiall has become an industry leader in providing innovative solutions to customers. From connectors to in-house technologies, Radiall's commitment to collaboration and innovation has made it a trusted partner for customers looking to build the future.



The VanSystem brand in the Radiall world distinguishes "heavy duty" connectors for railways and industrial applications.

The name origin is related to VanSystem, an Italian company founded in Milan in 1985 and specialized in the design and production of industrial connectors.

During 30 years of activity the company has gained a strong market position by developing interconnection solutions compliant with the SAE AS 50151 (ex MIL-DTL-5015) standard and tailor-made connectors for the railway, machine tools, automation, construction sites, power supply, extractive industries markets.

In 2015 Radiall SA took over the company; Radiall Italia was born in 2021, from the merger between VanSystem srl and Radiall Elettronica srl.

Radiall Italia S.r.l. Quality System is qualified according ISO 9001:2015 and ISO/TS 22163:2017 (IRIS)

IRIS
Certification



SPPC Connectors - Introduction



SPPC-PWL-2.0/SPPC-PWL

Single Pole Power Connectors:

Single-pole power connectors are designed to provide safe, reliable and quick connections for cable-to-cable or cable-to-equipment in electrical power distribution systems.

- 5-key polarization system and color coding prevent connection errors
- SPPC-PWL-2.0 Up to 500 A, 1.000 V/ SPPC-PWL Up to 750 A, 1.000 V
- SPPC-PWL-2.0 From 35 mm² to 150 mm² wire section/ SPPC-PWL From 35 mm² to 300 mm² wire section
- IP67 when mated (according to EN 60529)
- Finger Protected IP2x: pin and socket contacts
- Multi-louver contact system
- KSPC: keyed single-pole connector, individual keyways to prevent connection errors



Certified (see details in part number table)



- Certified (see details in part number table)



S-BOX

Distribution Box for Power Connectors:

S-BOX distribution box has been developed to guarantee greater safety in use. The connectors can only be inserted in sequence, on mating the final connector a non standard key locks the connectors in place.

- Polarisation system to prevent connection errors
- Up to 750 A, 1.000 V
- From 35 mm² to 300 mm² wire section
- IP67 when mated (according to EN 60529)
- Finger Protected IP2x: pin and socket contacts
- Multi-louver contact system



SPPC-HK

Compact Single Pole Power Connectors 250A/400A:

Single-pole power connectors up to 400 amps, keyed, fingerproof both sides, innovative locking mechanism.

- 5-key polarization system and color coding prevent connection errors
- Up to 400 A, 1.200 V
- From 16 mm² to 120 mm² wire section
- Multi-louver contact system
- Reduced flange size option
- No special tool is required for assembly or uncoupling
- Spring locking axial action
- IP67 when mated (according to EN 60529)
- IP2x finger-protected contacts
- KSPC: keyed single pole connector, individual keyways to prevent connection errors



SPPC LJP

Lug Joint Protector:

LJP is a safe and reliable temporary connection/extension of single core power cables that are pre-terminated with copper lug terminals.

- Up to 780 A, 1.000 V
- IP67 when mated (according to EN 60529)
- Accepts 120 mm², 185 mm², 240 mm² and 300 mm² lugs with holes size 12 mm
- Different lug sizes can be assembled in the same unit using special accessories

SPPC-PWL/ SPPC-PWL-2.0 Connectors - Introduction

Single Pole Power Connector

Single Pole Power Connectors have become widely adopted in a diverse range of applications and industries.

APPLICATIONS:

- Power distribution
- Utilities
- Electric Vehicles
- Railway Equipment
- Military Field Power
- Mobile Generators
- Loadbanks
- Back-up Power Systems

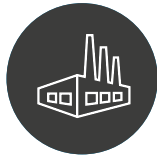

KEY CHARACTERISTICS:

- 500 Mating Cycles minimum
- Intermateable with other versions
- IP2X Finger Protected contacts
- IP67 sealed when mated
- Remote tool required to release the secondary locking of the mated connectors
- For use with Electrical Power Cables
- Heavy Duty Hand Grips
- Clip retained contacts
- Cotter pin required for panel mount connectors
- Cable sizes from 35mm² to 300mm²
- Facilitate cables up to 37mm Ø
- High Impact Insulators
- Harmonised Colour Coding
- CE Compliant
- EN/ESI compliant Creepage and Clearance distances
- Multi-louver contact system
- Mechanically keyed to prevent connection errors
- Permanent Phase Marking
- Set Screw and Crimp contact versions
- UL94 VO Flame Retardant
- Field Assembly & Repair
- Extraction tool required
- Eaisy Chain hook up system

FEATURES AND BENEFITS:

- Connectors coding key to prevent possible wrong connections.
- Mechanical key associated to harmonized colour system i.e. A Phase Line cannot be connected into Earth Line etc. i.e. in Europe Phase 1 is always brown
- secondary locking system



SPPC-PWL/ SPPC-PWL-2.0 Connectors - Introduction

Single Pole Power Connector

POWER CONNECTORS TYPES:

- **Source: Socket** connector is the source of the power, it receives and holds the Pin connector.
- **Drain: Pin** connectors receives and holds the Socket connector. The Drain connectors have a pin for the secondary locking (locks into the source connectors) The release key is required to unlock the secondary locking pin.
- **Cable/line: source (1) or drain (2)** is a moveable connectors fitted to a cable. The contacts are available in crimp or screw terminal.
- **Panel: source (3) or drain (4)** receptacle connectors to be fixed to a panel.

Power connectors cannot be mated/unmated under voltage or underloaded.

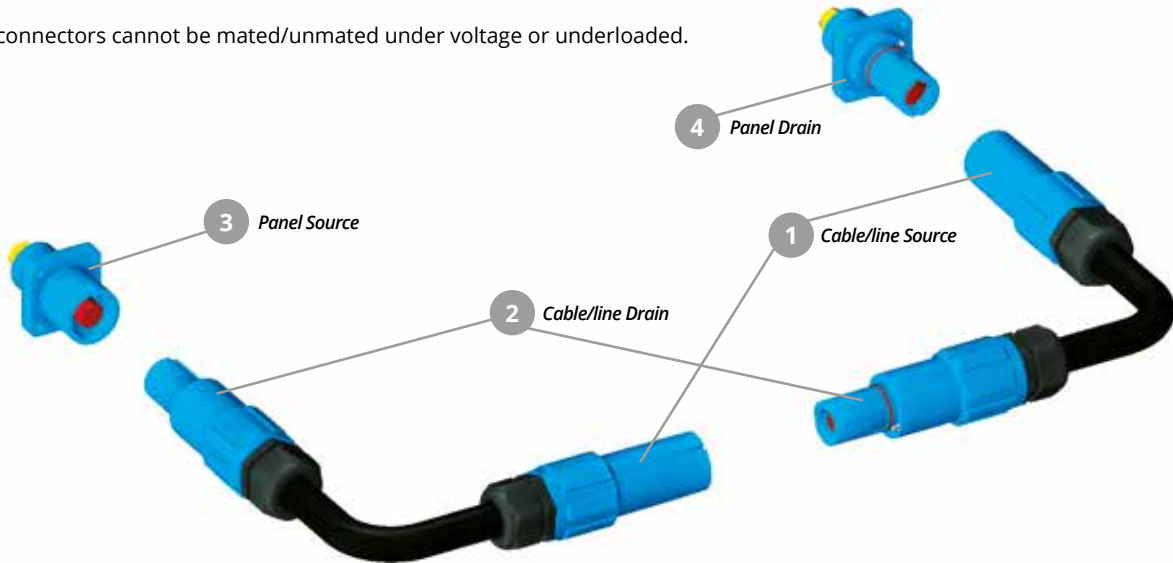

MECHANICALLY KEYED TO PREVENT CONNECTION ERRORS

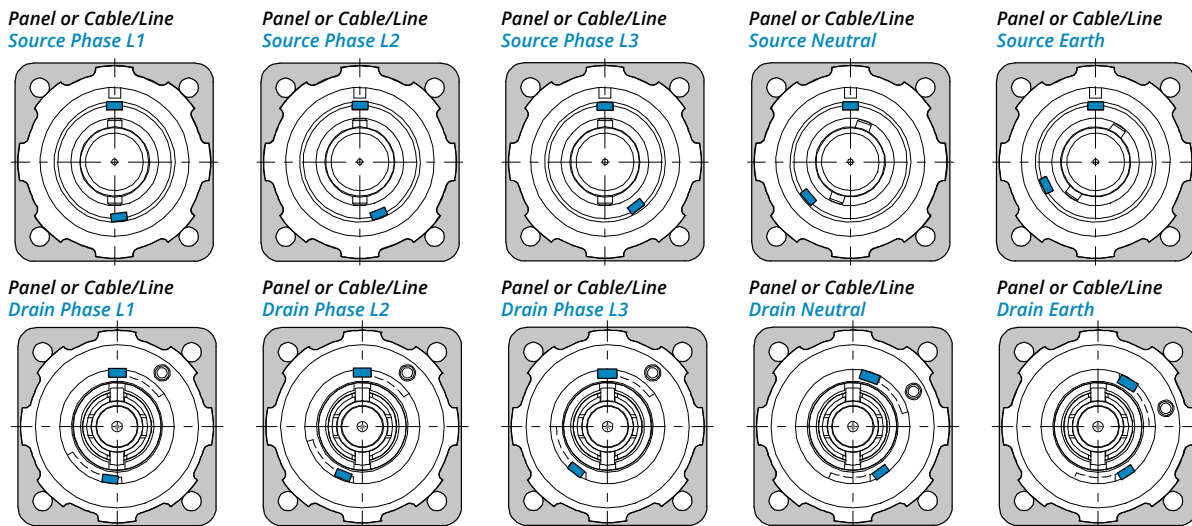

COLOUR CODING



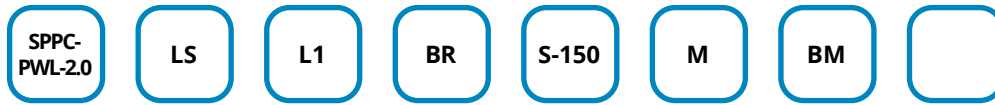

Standard	Phase L1		Phase L2		Phase L3		Neutral		Earth	
Europe	Brown (BR)		Black (BK)		Grey (GY)		Blue (BU)		Green (GN)	
USA (*)	Black (BK)		Red (RD)		Blue (BU)		White (WH)		Green (GN)	
Australia (*)	Red (RD)		White (WH)		Blue (BU)		Black (BK)		Green (GN)	
Direct current DC	-	-	Red (RD)		-	-	Black (BK)		Green (GN)	

* Color set on request

SPPC-PWL-2.0 Connectors - Part number explanation



P/N Sample: SPPC-PWL-2.0-LS-L1-BR-S-150

SPPC-PWL-2.0	Series Code	SPPC-PWL-2.0	Single Pole Power connectors
LS	Connector Type	LS	Cable/Line Source
		LD	Cable/Line Drain
		PS	Panel Source
		PD	Panel Drain
L1	Key Position	E	Earth
		N	Neutral
		L1	Phase 1
		L2	Phase 2
BR	Insulator Color	BR	 Brown
		BK	 Black
		GY	 Grey
		BU	 Blue
		GN	 Green
S-150	Contact Termination	S-150	Screw terminal – 500A up to 150mm ²
		M12-T5	M12 Threaded post – 500A
		TH5	Threaded hole – 500A
M	Cable External diameter	ES	9mm – 23mm
		S	15mm – 23mm
		M	19mm – 28mm
		OS	22mm – 32mm
BM	Contacts Type	-	Standard contacts
		BM	Bimetallic Contacts
 	Customization		

LINE DRAIN WITH INTEGRATED LOCKING RETENTION SYSTEM

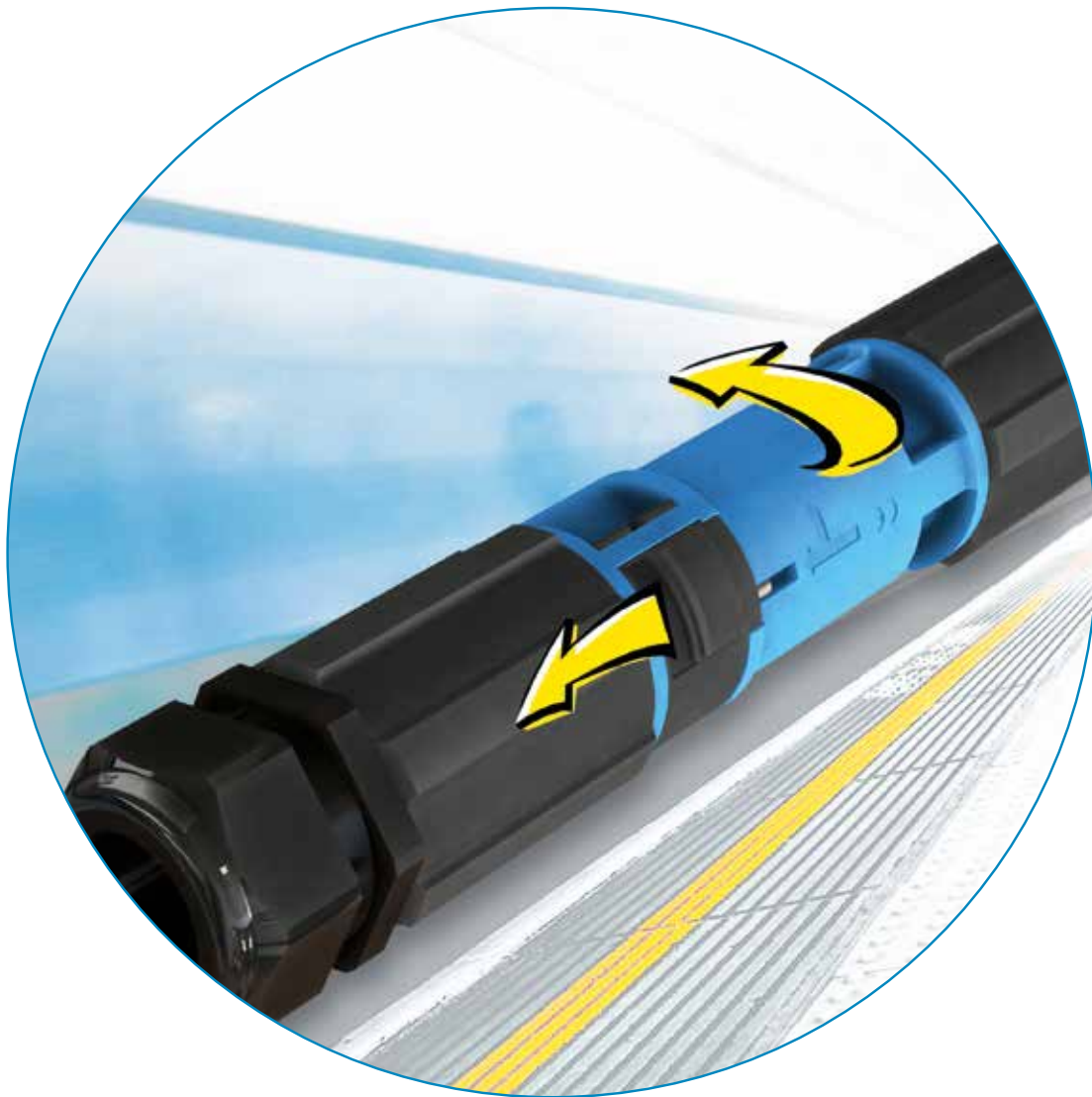

Easy and Fast Disconnection

The Line Drain integrated Locking Retention System has been developed for a quick disconnection without Release Key supplement.

SPPC-PWL-2.0 Connectors - Characteristics

Integrated Locking Retention System

1. Cable connectors mated and held in place via the secondary locking pin.

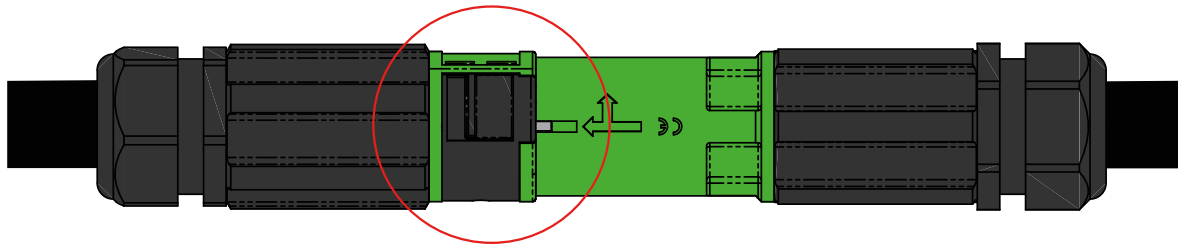

2. Release integrated sliding release key.

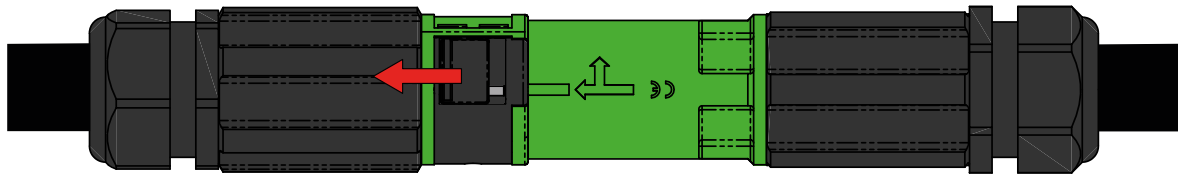

3. Twist to disengage key way.

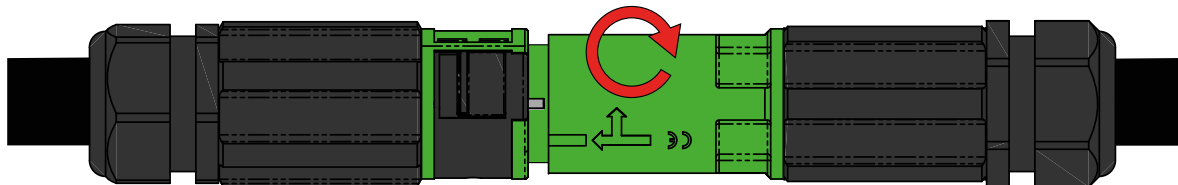

4. Uncouple connectors.
Warning – Do not uncouple under load.

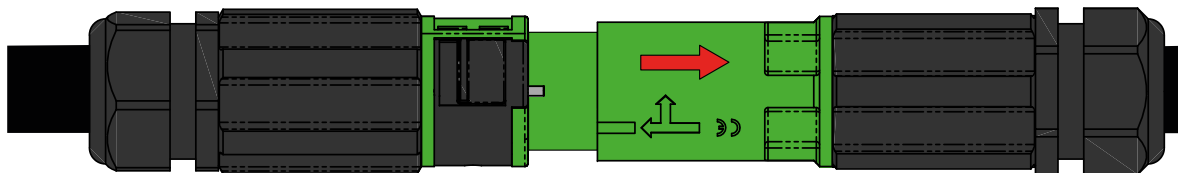

SPPC-PWL-2.0 Connectors - Disassembly Instruction Guide

1. Turn gland anti-clockwise to loosen.

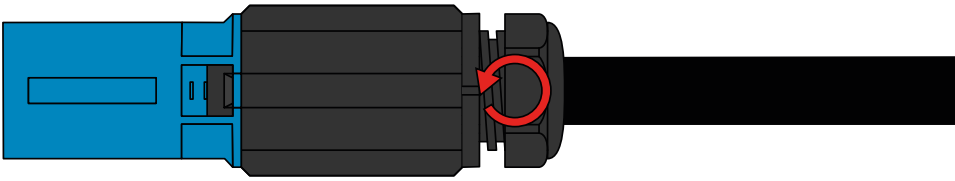

2. Unclip locator pin with small flat screwdriver.

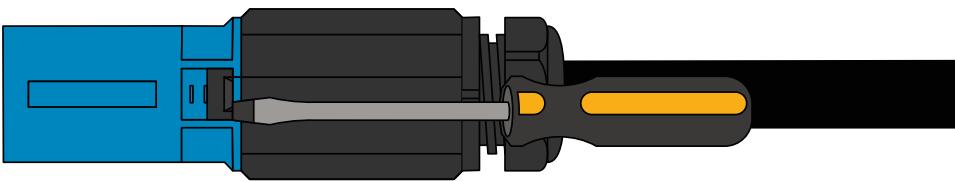

3. Slide locator pin down to unsecure it.

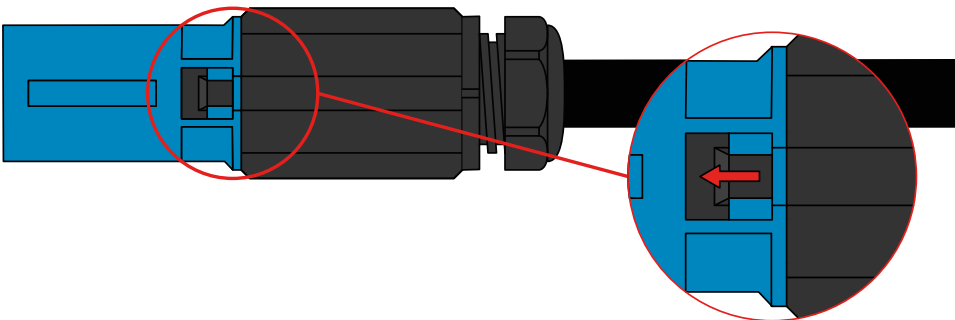

4. Turn backshell anti-clockwise to unscrew from front end.

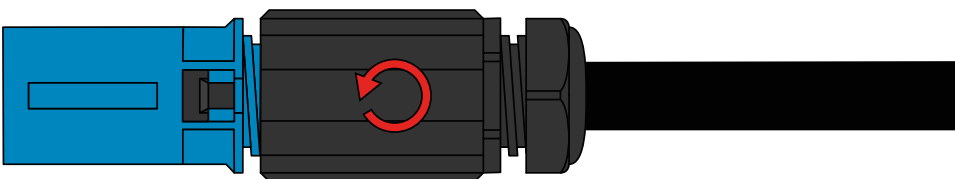

5. Remove front end from contact and slide backshell up the cable.

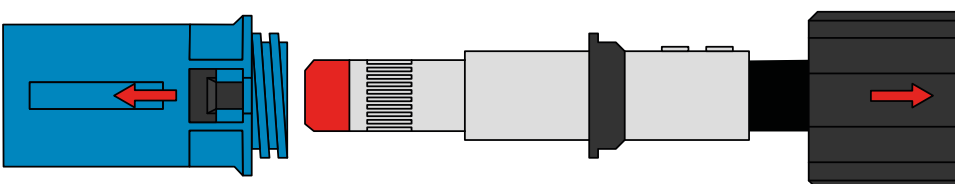

SPPC-PWL-2.0 Connectors - Assembly Instruction Guide

1. Remove packaging and disassemble connector by sliding locator pin up to unsecure, then turn backshell counter clockwise to remove and slide out contact.

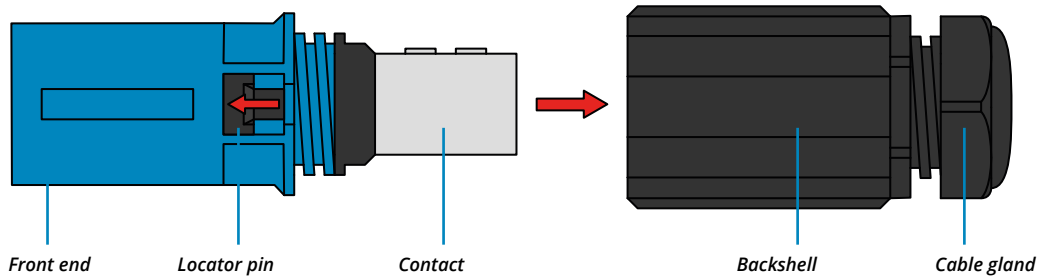

2. To reassemble, slide backshell and cable gland down the cable, fully insert terminated contact into the front end. Please note, on pin contact (as shown below) slotted keyway in contact must align with keyway in moulding. Not required on socket line drain.

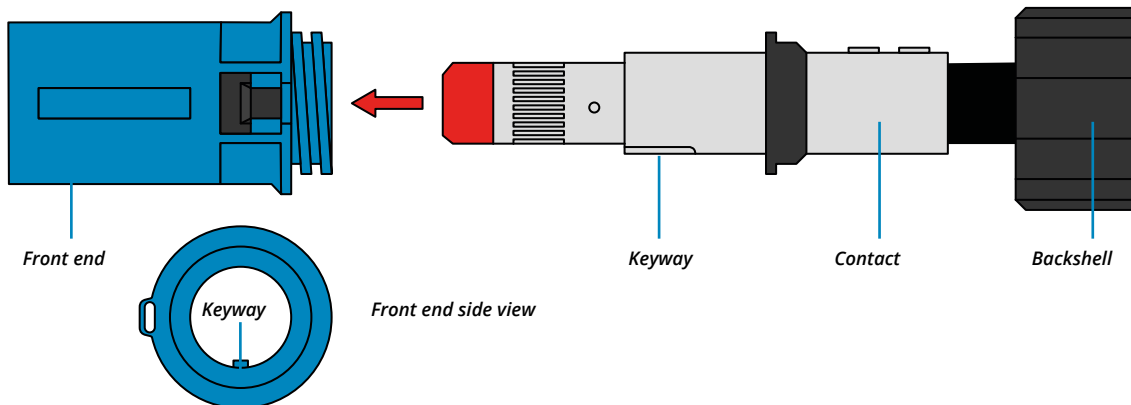

3. Place the backshell over the contact to connect with front end.

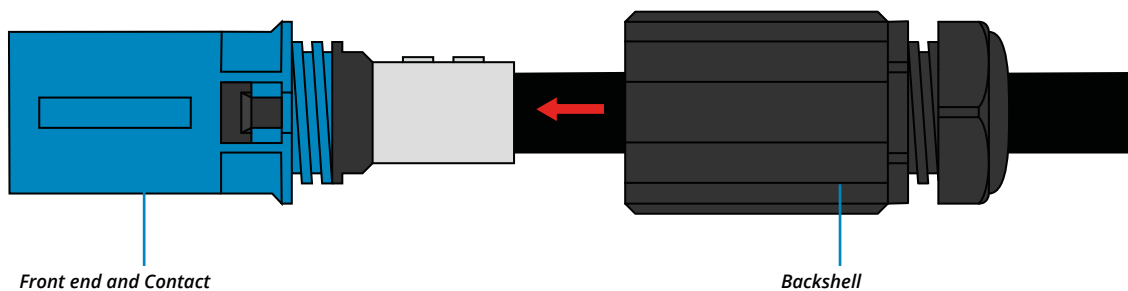

SPPC-PWL-2.0 Connectors - Assembly Instruction Guide

4. Turn backshell clockwise to screw into front end, making sure the hole on backshell is lined up with front end locator pin.

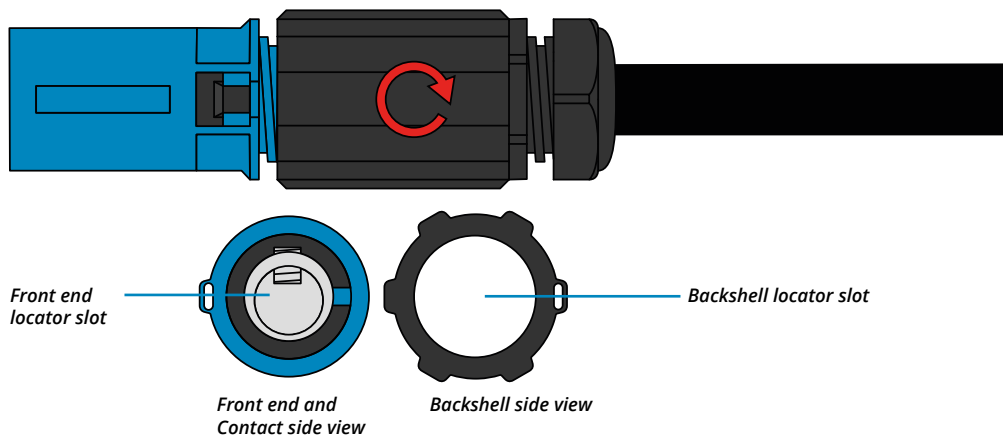

5. Slide locator pin up to make it secure.

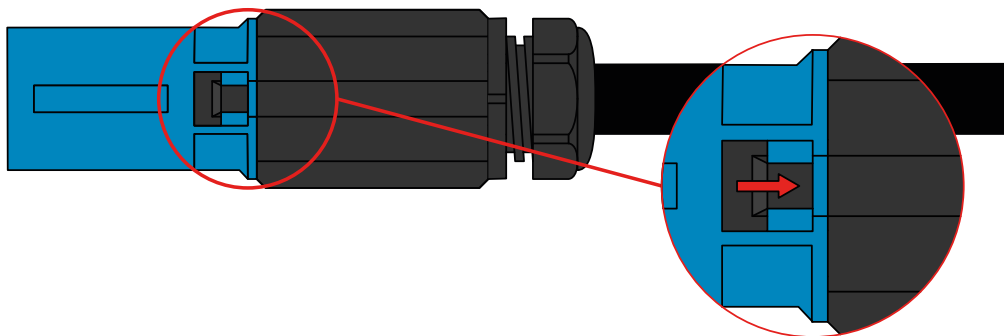

6. Completed.

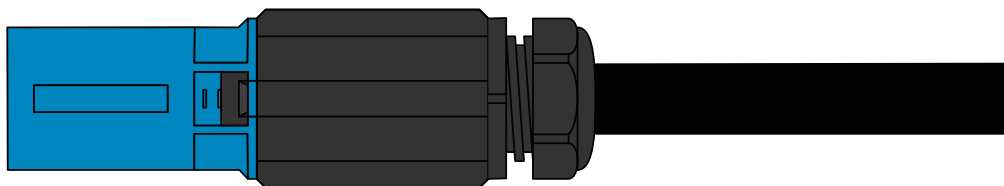





















SPPC-PWL-2.0 Connectors - Cable/Line drain - 1000V



500A

Screws terminal for conductor up to 150mm²**

Color*	Short Description	Part Number				
 Brown - Phase L1	SPPC-PWL-2.0-LD-L1-BR-S-150-M	VS392501				Certified
 Black - Phase L2	SPPC-PWL-2.0-LD-L2-BK-S-150-M	VS392502				Certified
 Grey - Phase L3	SPPC-PWL-2.0-LD-L3-GY-S-150-M	VS392503				Certified
 Blue - Neutral	SPPC-PWL-2.0-LD-N-BU-S-150-M	VS392504				Certified
 Green - Earth	SPPC-PWL-2.0-LD-E-GN-S-150-M	VS392505				Certified

** Sleeves included, for cable conductor size 35 mm² - 50 mm² - 70 mm² - 95 mm² - 120 mm² - 150 mm² (Up to maximum diameter 16.5mm). Insulating strip 33mm.

*European Harmonized Color Set, others colors set on request

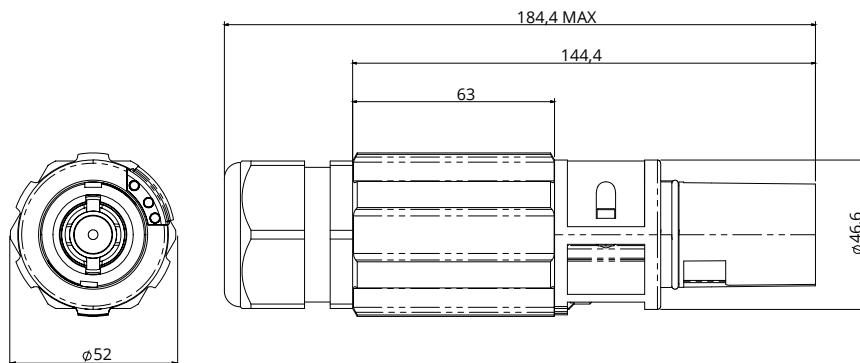















SPPC-PWL-2.0 Connectors - Cable/Line source - 1000V



500A

Screws terminal for conductor up to 150mm²**

Color*	Short Description	Part Number				
 Brown - Phase L1	SPPC-PWL-2.0-LS-L1-BR-S-150-M	VS392506			Certified	
 Black - Phase L2	SPPC-PWL-2.0-LS-L2-BK-S-150-M	VS392507			Certified	
 Grey - Phase L3	SPPC-PWL-2.0-LS-L3-GY-S-150-M	VS392508			Certified	
 Blue - Neutral	SPPC-PWL-2.0-LS-N-BU-S-150-M	VS392509			Certified	
 Green - Earth	SPPC-PWL-2.0-LS-E-GN-S-150-M	VS392510			Certified	

** Sleeves included, for cable conductor size 35 mm² - 50 mm² - 70 mm² - 95 mm² - 120 mm² - 150 mm² (Up to maximum diameter 16.5mm). Insulating strip 33mm.

*European Harmonized Color Set, others colors set on request

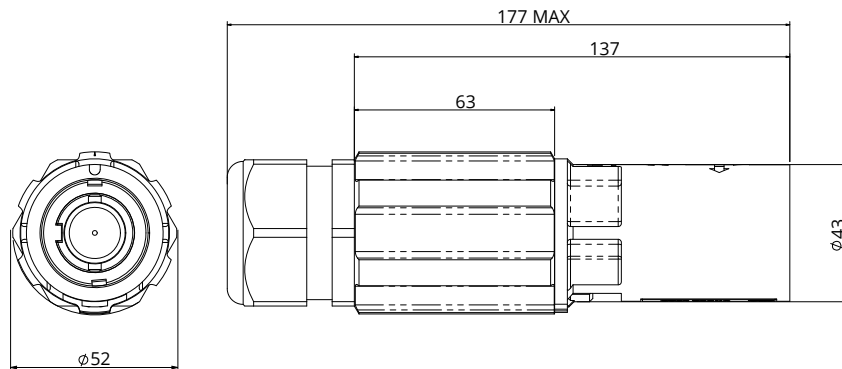

SPPC-PWL-2.0 Connectors - Panel drain - 1000V



500A

M12 Threaded post for conductor up to 300mm²

Color*	Short Description	Part Number			Certified
	Brown - Phase L1 SPPC-PWL-2.0-PD-L1-BR-M12-T5	VS392511			Certified
	Black - Phase L2 SPPC-PWL-2.0-PD-L2-BK-M12-T5	VS392512			Certified
	Grey - Phase L3 SPPC-PWL-2.0-PD-L3-GY-M12-T5	VS392513			Certified
	Blue - Neutral SPPC-PWL-2.0-PD-N-BU-M12-T5	VS392514			Certified
	Green - Earth SPPC-PWL-2.0-PD-E-GN-M12-T5	VS392515			Certified

500A

Threaded Hole

Color*	Short Description	Part Number			Certified
	Brown - Phase L1 SPPC-PWL-2.0-PD-L1-BR-TH5	VS392521			Certified
	Black - Phase L2 SPPC-PWL-2.0-PD-L2-BK-TH5	VS392522			Certified
	Grey - Phase L3 SPPC-PWL-2.0-PD-L3-GY-TH5	VS392523			Certified
	Blue - Neutral SPPC-PWL-2.0-PD-N-BU-TH5	VS392524			Certified
	Green - Earth SPPC-PWL-2.0-PD-E-GN-TH5	VS392525			Certified

*European Harmonized Color Set, others colors set on request

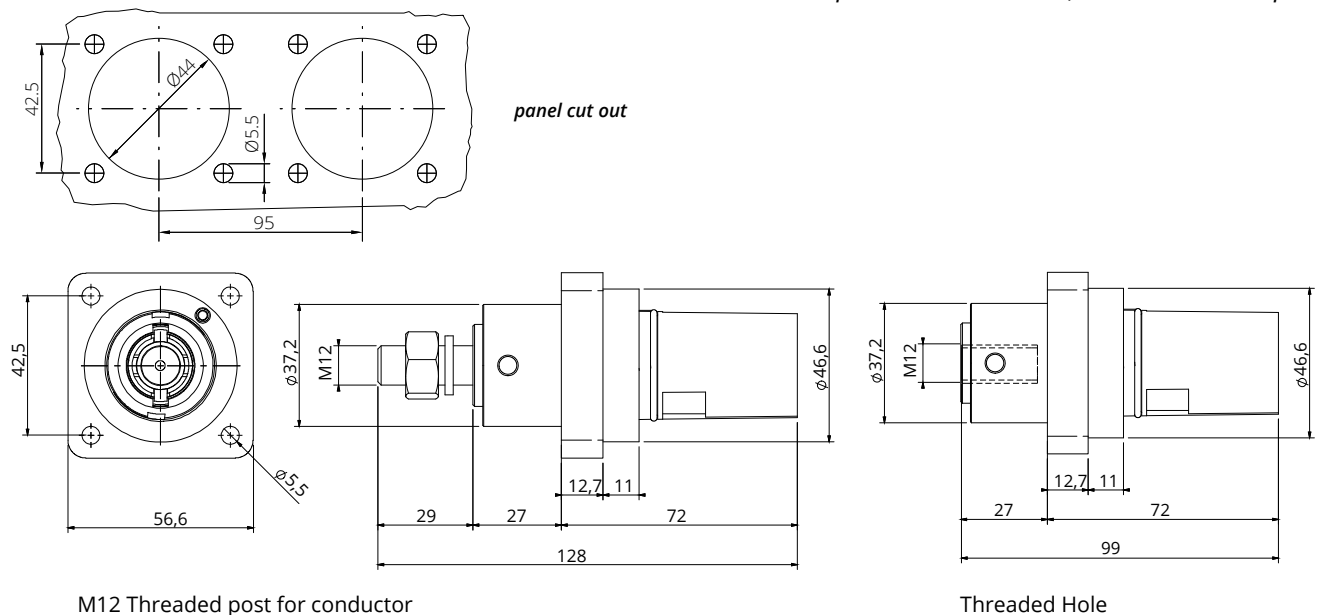















SPPC-PWL-2.0 Connectors - Panel source - 1000V

















500A

M12 Threaded post for conductor up to 300mm²

Color*	Short Description	Part Number			
 Brown - Phase L1	SPPC-PWL-2.0-PS-L1-BR-M12-T5	VS392516			Certified
 Black - Phase L2	SPPC-PWL-2.0-PS-L2-BK-M12-T5	VS392517			Certified
 Grey - Phase L3	SPPC-PWL-2.0-PS-L3-GY-M12-T5	VS392518			Certified
 Blue - Neutral	SPPC-PWL-2.0-PS-N-BU-M12-T5	VS392519			Certified
 Green - Earth	SPPC-PWL-2.0-PS-E-GN-M12-T5	VS392520			Certified

500A

Threaded Hole

Color*	Short Description	Part Number			
 Brown - Phase L1	SPPC-PWL-2.0-PS-L1-BR-TH5	VS392526			Certified
 Black - Phase L2	SPPC-PWL-2.0-PS-L2-BK-TH5	VS392527			Certified
 Grey - Phase L3	SPPC-PWL-2.0-PS-L3-GY-TH5	VS392528			Certified
 Blue - Neutral	SPPC-PWL-2.0-PS-N-BU-TH5	VS392529			Certified
 Green - Earth	SPPC-PWL-2.0-PS-E-GN-TH5	VS392530			Certified

*European Harmonized Color Set, others colors set on request

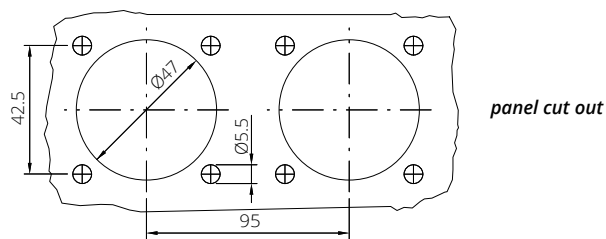

panel cut out

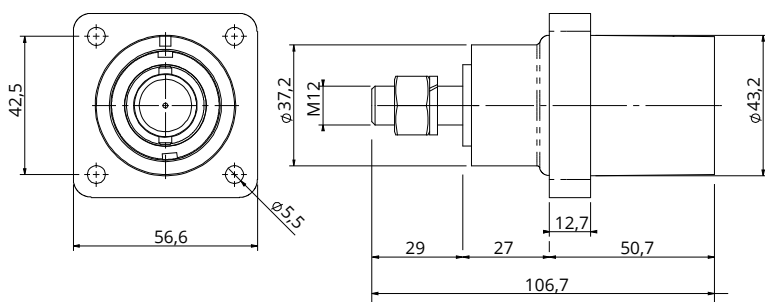

M12 Threaded post for conductor

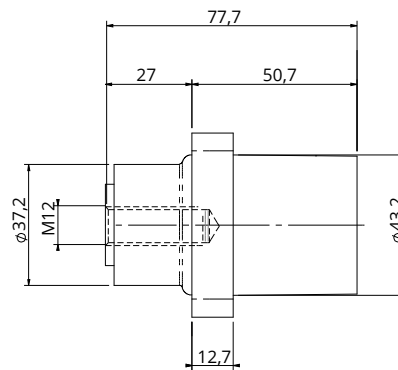









Threaded Hole

SPPC-PWL Connectors - Part number explanation



P/N Sample: SPPC-PWL-LS-L1-BR-C-240-M

SPPC-PWL	Series Code	SPPC-PWL	Single Pole Power connectors
LS	Connector Type	LS	Cable/Line Source
		LD	Cable/Line Drain
		PS	Panel Source
		PD	Panel Drain
L1	Key Position	E	Earth
		N	Neutral
		L1	Phase 1
		L2	Phase 2
BR	Insulator Color	L3	Phase 3
		BR	 Brown
		BK	 Black
		GY	 Grey
		BU	 Blue
		GN	 Green
		RD	 Red (<i>consult our sales office</i>)
		YL	 Yellow (<i>consult our sales office</i>)
C-240	Contact Termination*	WH	 White (<i>consult our sales office</i>)
		M12-T7	M12 Threaded post - 750A
		M12-T4	M12 Threaded post - 400A
		S-120	Screw terminal - 400A up to 120mm ²
		C-35	Crimp contacts - 500A 35mm ²
		C-50	Crimp contacts - 500A 50mm ²
		C-70	Crimp contacts - 500A 70mm ²
		C-95	Crimp contacts - 500A 95mm ²
		C-120	Crimp contacts - 500A 120mm ²
		C-150	Crimp contacts - 500A 150mm ²
		C-185	Crimp contacts - 750A 185mm ²
		C-240	Crimp contacts - 750A 240mm ²
		C-300	Crimp contacts - 750A 300mm ²
		TH7	Threaded hole - 750A
		TH4	Threaded hole - 400A
M	Cable External diameter	L	Contacts for Lug
		ES	9mm - 23mm
		S	15mm - 23mm
		M	19mm - 28mm
		OS	22mm - 32mm
		M50	27mm - 35mm
BM	Contacts Type	OS-M50	30mm - 38mm
		-	Standard contacts
BM	Contacts Type	BM	Bimetallic Contacts (400A / 500A)
	Customization		

* Permissible cable rating (A) to be checked with the specific cable characteristic

SPPC-PWL Connectors - Dimensions

Panel Drain Connectors M12 Threaded post for conductor

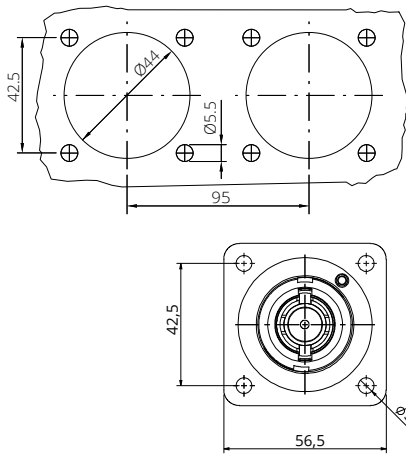

Panel cut out Drain connectors

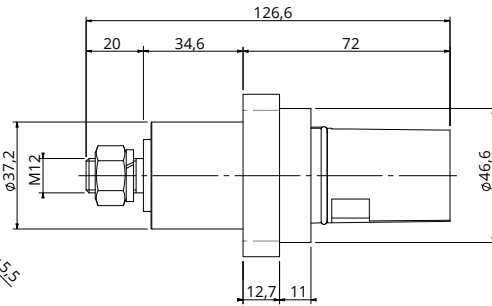

Panel Drain Connectors Threaded Hole

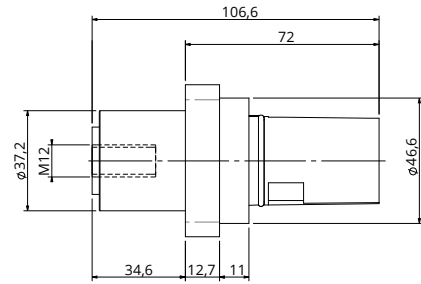

Panel Source Connectors M12 Threaded post for conductor

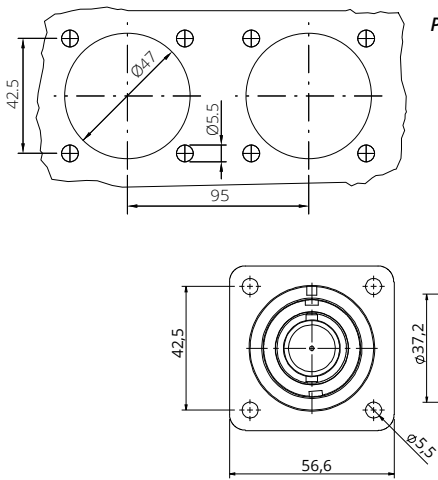

Panel cut out Source connectors

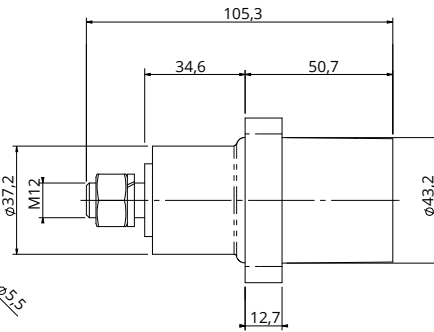

Panel Source Connectors Threaded Hole

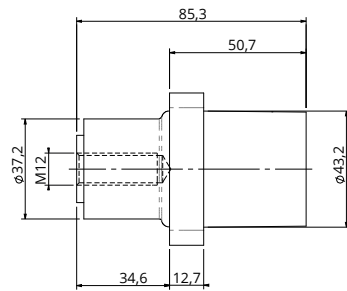

Cable/Line Source Connectors

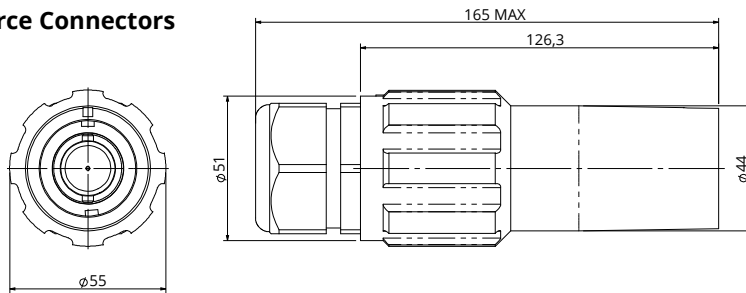

Cable/Line Drain Connectors

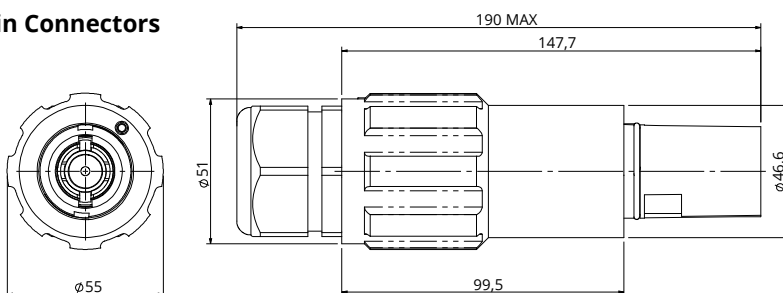















SPPC-PWL Connectors - Panel drain - 1000V













400A

M12 Threaded post for conductor up to 120mm²

Color*	Short Description	Part Number			
 Brown – Phase L1	SPPC-PWL-PD-L1-BR-M12-T4	VS390070			Certified
 Black – Phase L2	SPPC-PWL-PD-L2-BK-M12-T4	VS390071			Certified
 Grey – Phase L3	SPPC-PWL-PD-L3-GY-M12-T4	VS390072			Certified
 Blue – Neutral	SPPC-PWL-PD-N-BU-M12-T4	VS390068			Certified
 Green – Earth	SPPC-PWL-PD-E-GN-M12-T4	VS390263			Certified











750A

M12 Threaded post for conductor up to 300mm²

Color*	Short Description	Part Number		
 Brown – Phase L1	SPPC-PWL-PD-L1-BR-M12-T7	VS390110		Certified
 Black – Phase L2	SPPC-PWL-PD-L2-BK-M12-T7	VS390111		Certified
 Grey – Phase L3	SPPC-PWL-PD-L3-GY-M12-T7	VS390112		Certified
 Blue – Neutral	SPPC-PWL-PD-N-BU-M12-T7	VS390113		Certified
 Green – Earth	SPPC-PWL-PD-E-GN-M12-T7	VS390109		Certified

750A

Threaded Hole

Color*	Short Description	Part Number		
 Brown – Phase L1	SPPC-PWL-PD-L1-BR-TH7	VS390280		Certified
 Black – Phase L2	SPPC-PWL-PD-L2-BK-TH7	VS390281		Certified
 Grey – Phase L3	SPPC-PWL-PD-L3-GY-TH7	VS390282		Certified
 Blue – Neutral	SPPC-PWL-PD-N-BU-TH7	VS390283		Certified
 Green – Earth	SPPC-PWL-PD-E-GN-TH7	VS390284		Certified

*European Harmonized Color Set, others colors set on request

SPPC-PWL Connectors - Panel source - 1000V



400A

M12 Threaded post for conductor up to 120mm²

Color*	Short Description	Part Number			Certified
Brown – Phase L1	SPPC-PWL-PS-L1-BR-M12-T4	VS390065			Certified
Black – Phase L2	SPPC-PWL-PS-L2-BK-M12-T4	VS390132			Certified
Grey – Phase L3	SPPC-PWL-PS-L3-GY-M12-T4	VS390067			Certified
Blue – Neutral	SPPC-PWL-PS-N-BU-M12-T4	VS390063			Certified
Green – Earth	SPPC-PWL-PS-E-GN-M12-T4	VS390064			Certified

750A

M12 Threaded post for conductor up to 300mm²

Color*	Short Description	Part Number		Certified
Brown – Phase L1	SPPC-PWL-PS-L1-BR-M12-T7	VS390100		Certified
Black – Phase L2	SPPC-PWL-PS-L2-BK-M12-T7	VS390101		Certified
Grey – Phase L3	SPPC-PWL-PS-L3-GY-M12-T7	VS390102		Certified
Blue – Neutral	SPPC-PWL-PS-N-BU-M12-T7	VS399000		Certified
Green – Earth	SPPC-PWL-PS-E-GN-M12-T7	VS399004		Certified

750A

Threaded Hole

Color*	Short Description	Part Number		Certified
Brown – Phase L1	SPPC-PWL-PS-L1-BR-TH7	VS390290		Certified
Black – Phase L2	SPPC-PWL-PS-L2-BK-TH7	VS390291		Certified
Grey – Phase L3	SPPC-PWL-PS-L3-GY-TH7	VS390292		Certified
Blue – Neutral	SPPC-PWL-PS-N-BU-TH7	VS390293		Certified
Green – Earth	SPPC-PWL-PS-E-GN-TH7	VS390294		Certified















*European Harmonized Color Set, others colors set on request

SPPC-PWL Connectors - Cable/Line drain - 1000V



400A











Screws terminal for conductor up to 120mm²**

Color*	Short Description	Part Number			
 Brown - Phase L1	SPPC-PWL-LD-L1-BR-S-120-M	VS390091			Certified
 Black - Phase L2	SPPC-PWL-LD-L2-BK-S-120-M	VS390092			Certified
 Grey - Phase L3	SPPC-PWL-LD-L3-GY-S-120-M	VS390093			Certified
 Blue - Neutral	SPPC-PWL-LD-N-BU-S-120-M	VS390090			Certified
 Green - Earth	SPPC-PWL-LD-E-GN-S-120-M	VS390089			Certified

750A











Crimp contacts 300mm²

** Sleeves included, for cable conductor size 35 mm² - 50 mm² - 70 mm² - 95 mm² - 120 mm²

Color*	Short Description	Part Number		
 Brown - Phase L1	SPPC-PWL-LD-L1-BR-C-300-OS	VS390275		Certified
 Black - Phase L2	SPPC-PWL-LD-L2-BK-C-300-OS	VS390276		Certified
 Grey - Phase L3	SPPC-PWL-LD-L3-GY-C-300-OS	VS390277		Certified
 Blue - Neutral	SPPC-PWL-LD-N-BU-C-300-OS	VS390278		Certified
 Green - Earth	SPPC-PWL-LD-E-GN-C-300-OS	VS390279		Certified











750A

Crimp contacts 240mm²

Color*	Short Description	Part Number		
 Brown - Phase L1	SPPC-PWL-LD-L1-BR-C-240-OS	VS390105		Certified
 Black - Phase L2	SPPC-PWL-LD-L2-BK-C-240-OS	VS390106		Certified
 Grey - Phase L3	SPPC-PWL-LD-L3-GY-C-240-OS	VS390107		Certified
 Blue - Neutral	SPPC-PWL-LD-N-BU-C-240-OS	VS390274		Certified
 Green - Earth	SPPC-PWL-LD-E-GN-C-240-OS	VS390104		Certified

750A

Crimp contacts 185mm²

Color*	Short Description	Part Number		
 Brown - Phase L1	SPPC-PWL-LD-L1-BR-C-185-OS	VS390126		Certified
 Black - Phase L2	SPPC-PWL-LD-L2-BK-C-185-OS	VS390127		Certified
 Grey - Phase L3	SPPC-PWL-LD-L3-GY-C-185-OS	VS390128		Certified
 Blue - Neutral	SPPC-PWL-LD-N-BU-C-185-OS	VS390130		Certified
 Green - Earth	SPPC-PWL-LD-E-GN-C-185-OS	VS390129		Certified

*European Harmonized Color Set, others colors set on request

SPPC-PWL Connectors - Cable/Line source - 1000V



400A

Screws terminal for conductor up to 120mm²**

Color*	Short Description	Part Number			
Brown - Phase L1	SPPC-PWL-LS-L1-BR-S-120-M	VS390086			Certified
Black - Phase L2	SPPC-PWL-LS-L2-BK-S-120-M	VS390087			Certified
Grey - Phase L3	SPPC-PWL-LS-L3-GY-S-120-M	VS390088			Certified
Blue - Neutral	SPPC-PWL-LS-N-BU-S-120-M	VS390085			Certified
Green - Earth	SPPC-PWL-LS-E-GN-S-120-M	VS390084			Certified

750A

** Sleeves included, for cable conductor size 35 mm² - 50 mm² - 70 mm² - 95 mm² - 120 mm²

Crimp contacts 300mm²

Color*	Short Description	Part Number		
Brown - Phase L1	SPPC-PWL-LS-L1-BR-C-300-OS	VS390197		Certified
Black - Phase L2	SPPC-PWL-LS-L2-BK-C-300-OS	VS390198		Certified
Grey - Phase L3	SPPC-PWL-LS-L3-GY-C-300-OS	VS390199		Certified
Blue - Neutral	SPPC-PWL-LS-N-BU-C-300-OS	VS390300		Certified
Green - Earth	SPPC-PWL-LS-E-GN-C-300-OS	VS390196		Certified

750A

Crimp contacts 240mm²

Color*	Short Description	Part Number		
Brown - Phase L1	SPPC-PWL-LS-L1-BR-C-240-OS	VS390115		Certified
Black - Phase L2	SPPC-PWL-LS-L2-BK-C-240-OS	VS390116		Certified
Grey - Phase L3	SPPC-PWL-LS-L3-GY-C-240-OS	VS390117		Certified
Blue - Neutral	SPPC-PWL-LS-N-BU-C-240-OS	VS390118		Certified
Green - Earth	SPPC-PWL-LS-E-GN-C-240-OS	VS390114		Certified

750A

Crimp contacts 185mm²

Color*	Short Description	Part Number		
Brown - Phase L1	SPPC-PWL-LS-L1-BR-C-185-OS	VS390235		Certified
Black - Phase L2	SPPC-PWL-LS-L2-BK-C-185-OS	VS390154		Certified
Grey - Phase L3	SPPC-PWL-LS-L3-GY-C-185-OS	VS390155		Certified
Blue - Neutral	SPPC-PWL-LS-N-BU-C-185-OS	VS390225		Certified
Green - Earth	SPPC-PWL-LS-E-GN-C-185-OS	VS390226		Certified





*European Harmonized Color Set, others colors set on request

SPPC-PWL Connectors - Panel Connectors - 1000V



Panel Source Connectors

Moulding for replacement, contacts and panel gasket to be order separately



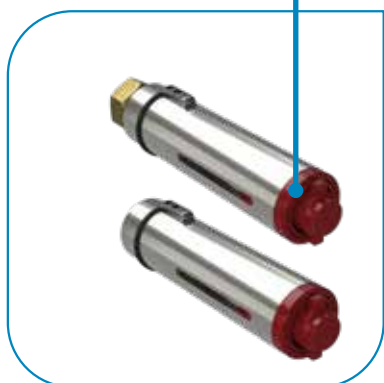

Color*	Short Description	Part Number
 Brown - Phase L1	SPPC-PWL-PS-ISOL-L1-BR	VS392101
 Black - Phase L2	SPPC-PWL-PS-ISOL-L2-BK	VS392102
 Grey - Phase L3	SPPC-PWL-PS-ISOL-L3-GY	VS392103
 Blue - Neutral	SPPC-PWL-PS-ISOL-N-BU	VS392104
 Green - Earth	SPPC-PWL-PS-ISOL-E-GN	VS392105

Type	Short Description	Part Number
Source - M12 Threaded post - 750A	SPPC-PWL-PS-CONT-M12-750A	VS392201
Source - M12 Threaded post - 400A	SPPC-PWL-PS-CONT-M12-400A	VS392203
Source - Threaded Hole - 750A	SPPC-PWL-PS-CONT-TH-750A	VS392205
Source - Threaded Hole - 400A	SPPC-PWL-PS-CONT-TH-400A	VS392207



Panel Drain Connectors

Moulding for replacement, contacts and panel gasket to be order separately

Color*	Short Description	Part Number
 Brown - Phase L1	SPPC-PWL-PD-ISOL-L1-BR	VS392106
 Black - Phase L2	SPPC-PWL-PD-ISOL-L2-BK	VS392107
 Grey - Phase L3	SPPC-PWL-PD-ISOL-L3-GY	VS392108
 Blue - Neutral	SPPC-PWL-PD-ISOL-N-BU	VS392109
 Green - Earth	SPPC-PWL-PD-ISOL-E-GN	VS392110

Type	Short Description	Part Number
Drain - M12 Threaded post - 750A	SPPC-PWL-PD-CONT-M12-750A	VS392202
Drain - M12 Threaded post - 400A	SPPC-PWL-PD-CONT-M12-400A	VS392204
Drain - Threaded Hole - 750A	SPPC-PWL-PD-CONT-TH-750A	VS392206
Drain - Threaded Hole - 400A	SPPC-PWL-PD-CONT-TH-400A	VS392208





*European Harmonized Color Set, others colors set on request

SPPC-PWL Connectors - Cable/Line Connectors - 1000V



Cable/Line Source Connectors

Moulding for replacement, contacts and cable gland to be order separately





Color*	Short Description	Part Number
 Brown - Phase L1	SPPC-PWL-LS-ISOL-L1-BR	VS392111
 Black - Phase L2	SPPC-PWL-LS-ISOL-L2-BK	VS392112
 Grey - Phase L3	SPPC-PWL-LS-ISOL-L3-GY	VS392113
 Blue - Neutral	SPPC-PWL-LS-ISOL-N-BU	VS392114
 Green - Earth	SPPC-PWL-LS-ISOL-E-GN	VS392115

Type	Short Description	Part Number
Source - Screw up to 35mm ² -120mm ² ** - 400A	SPPC-PWL-LS-CONT-S-400A	VS392209
Source - Crimp contacts 185 mm ² - 750A	SPPC-PWL-LS-CONT-CRIMP.185-750A	VS392211
Source - Crimp contacts 240 mm ² - 750A	SPPC-PWL-LS-CONT-CRIMP.240-750A	VS392213
Source - Crimp contacts 300 mm ² - 750A	SPPC-PWL-LS-CONT-CRIMP.300-750A	VS392215



Cable/Line Drain Connectors

Moulding for replacement, contacts and cable gland to be order separately

Color*	Short Description	Part Number
 Brown - Phase L1	SPPC-PWL-LD-ISOL-L1-BR	VS392116
 Black - Phase L2	SPPC-PWL-LD-ISOL-L2-BK	VS392117
 Grey - Phase L3	SPPC-PWL-LD-ISOL-L3-GY	VS392118
 Blue - Neutral	SPPC-PWL-LD-ISOL-N-BU	VS392119
 Green - Earth	SPPC-PWL-LD-ISOL-E-GN	VS392120

Type	Short Description	Part Number
Drain - Screw up to 35mm ² -120mm ² ** - 400A	SPPC-PWL-LD-CONT-S-400A	VS392210
Drain - Crimp contacts 185 mm ² - 750A	SPPC-PWL-LD-CONT-CRIMP.185-750A	VS392212
Drain - Crimp contacts 240 mm ² - 750A	SPPC-PWL-LD-CONT-CRIMP.240-750A	VS392214
Drain - Crimp contacts 300 mm ² - 750A	SPPC-PWL-LD-CONT-CRIMP.300-750A	VS392216

*European Harmonized Color Set, others colors set on request





SPPC-PWL Connectors - Cable/Line drain - 1000V - 500A**

BIMETALLIC CONNECTORS FOR ALUMINIUM CABLES

For crimping tool and crimping die, please consult our commercial office.







Crimp contacts 300mm², cable external diameter 33mm – 37mm

Color*	Short Description	Part Number
 Brown – Phase L1	SPPC-PWL-LD-L1-BR-C-300-OS-M50-BM	VS390432
 Black – Phase L2	SPPC-PWL-LD-L2-BK-C-300-OS-M50-BM	VS390433
 Grey – Phase L3	SPPC-PWL-LD-L3-GY-C-300-OS-M50-BM	VS390434
 Blue – Neutral	SPPC-PWL-LD-N-BU-C-300-OS-M50-BM	VS390431
 Green – Earth	SPPC-PWL-LD-E-GN-C-300-OS-M50-BM	VS390430







Crimp contacts 240mm², cable external diameter 33mm – 37mm**

** on request version OS-BM with cable external diameter 22mm – 32mm

Color*	Short Description	Part Number
 Brown – Phase L1	SPPC-PWL-LD-L1-BR-C-240-OS-M50-BM	VS390422
 Black – Phase L2	SPPC-PWL-LD-L2-BK-C-240-OS-M50-BM	VS390423
 Grey – Phase L3	SPPC-PWL-LD-L3-GY-C-240-OS-M50-BM	VS390424
 Blue – Neutral	SPPC-PWL-LD-N-BU-C-240-OS-M50-BM	VS390421
 Green – Earth	SPPC-PWL-LD-E-GN-C-240-OS-M50-BM	VS390420



Crimp contacts 185mm², cable external diameter 22mm – 32mm

Color*	Short Description	Part Number
 Brown – Phase L1	SPPC-PWL-LD-L1-BR-C-185-OS-BM	VS390402
 Black – Phase L2	SPPC-PWL-LD-L2-BK-C-185-OS-BM	VS390403
 Grey – Phase L3	SPPC-PWL-LD-L3-GY-C-185-OS-BM	VS390404
 Blue – Neutral	SPPC-PWL-LD-N-BU-C-185-OS-BM	VS390401
 Green – Earth	SPPC-PWL-LD-E-GN-C-185-OS-BM	VS390400

** Permissible cable rating (A) to be checked with the specific cable characteristic

*European Harmonized Color Set, others colors set on request





SPPC-PWL Connectors - Cable/Line source - 1000V - 500A**

BIMETALLIC CONNECTORS FOR ALUMINIUM CABLES

For crimping tool and crimping die, please consult our commercial office.







Crimp contacts 300mm², cable external diameter 33mm – 37mm

Color*	Short Description	Part Number	
	Brown – Phase L1	SPPC-PWL-LS-L1-BR-C-300-OS-M50-BM	VS390437
	Black – Phase L2	SPPC-PWL-LS-L2-BK-C-300-OS-M50-BM	VS390438
	Grey – Phase L3	SPPC-PWL-LS-L3-GY-C-300-OS-M50-BM	VS390439
	Blue – Neutral	SPPC-PWL-LS-N-BU-C-300-OS-M50-BM	VS390436
	Green – Earth	SPPC-PWL-LS-E-GN-C-300-OS-M50-BM	VS390435







Crimp contacts 240mm², cable external diameter 33mm – 37mm**

** on request version OS-BM with cable external diameter 22mm – 32mm

Color*	Short Description	Part Number	
	Brown – Phase L1	SPPC-PWL-LS-L1-BR-C-240-OS-M50-BM	VS390427
	Black – Phase L2	SPPC-PWL-LS-L2-BK-C-240-OS-M50-BM	VS390428
	Grey – Phase L3	SPPC-PWL-LS-L3-GY-C-240-OS-M50-BM	VS390429
	Blue – Neutral	SPPC-PWL-LS-N-BU-C-240-OS-M50-BM	VS390426
	Green – Earth	SPPC-PWL-LS-E-GN-C-240-OS-M50-BM	VS390425



Crimp contacts 185mm², cable external diameter 22mm – 32mm

Color*	Short Description	Part Number	
	Brown – Phase L1	SPPC-PWL-LS-L1-BR-C-185-OS-BM	VS390407
	Black – Phase L2	SPPC-PWL-LS-L2-BK-C-185-OS-BM	VS390408
	Grey – Phase L3	SPPC-PWL-LS-L3-GY-C-185-OS-BM	VS390409
	Blue – Neutral	SPPC-PWL-LS-N-BU-C-185-OS-BM	VS390406
	Green – Earth	SPPC-PWL-LS-E-GN-C-185-OS-BM	VS390405

** Permissible cable rating (A) to be checked with the specific cable characteristic

*European Harmonized Color Set, others colors set on request

SPPC-PWL Connectors - Cable/Line - 1000V - 400/500A**





BIMETALLIC CONNECTORS FOR ALUMINIUM CABLES

For crimping tool and crimping die, please consult our commercial office.



Cable/Line Drain





Crimp contacts 120mm², cable external diameter 19mm – 28mm - **400A**

Color*	Short Description	Part Number	
	Brown – Phase L1	SPPC-PWL-LD-L1-BR-C-120-M-BM	VS390456
	Black – Phase L2	SPPC-PWL-LD-L2-BK-C-120-M-BM	VS390457
	Grey – Phase L3	SPPC-PWL-LD-L3-GY-C-120-M-BM	VS390458
	Blue – Neutral	SPPC-PWL-LD-N-BU-C-120-M-BM	VS390459
	Green – Earth	SPPC-PWL-LD-E-GN-C-120-M -BM	on request



Cable/Line Drain





Crimp contacts 150mm², cable external diameter 19mm – 28mm - **500A**

Color*	Short Description	Part Number	
	Brown – Phase L1	SPPC-PWL-LD-L1-BR-C-150-M-BM	VS390448
	Black – Phase L2	SPPC-PWL-LD-L2-BK-C-150-M-BM	VS390449
	Grey – Phase L3	SPPC-PWL-LD-L3-GY-C-150-M-BM	VS390450
	Blue – Neutral	SPPC-PWL-LD-N-BU-C-150-M-BM	VS390451
	Green – Earth	SPPC-PWL-LD-E-GN-C-150-M -BM	on request



Cable/Line Source





Crimp contacts 120mm², cable external diameter 19mm – 28mm - **400A**

Color*	Short Description	Part Number	
	Brown – Phase L1	SPPC-PWL-LS-L1-BR-C-120-M-BM	VS390452
	Black – Phase L2	SPPC-PWL-LS-L2-BK-C-120-M-BM	VS390453
	Grey – Phase L3	SPPC-PWL-LS-L3-GY-C-120-M-BM	VS390454
	Blue – Neutral	SPPC-PWL-LS-N-BU-C-120-M-BM	VS390455
	Green – Earth	SPPC-PWL-LS-E-GN-C-120-M-BM	on request



Cable/Line Source

Crimp contacts 150mm², cable external diameter 19mm – 28mm - **500A**

Color*	Short Description	Part Number	
	Brown – Phase L1	SPPC-PWL-LS-L1-BR-C-150-M-BM	VS390444
	Black – Phase L2	SPPC-PWL-LS-L2-BK-C-150-M-BM	VS390445
	Grey – Phase L3	SPPC-PWL-LS-L3-GY-C-150-M-BM	VS390446
	Blue – Neutral	SPPC-PWL-LS-N-BU-C-150-M-BM	VS390447
	Green – Earth	SPPC-PWL-LS-E-GN-C-150-M-BM	on request

** Permissible cable rating (A) to be checked with the specific cable characteristic

*European Harmonized Color Set, others colors set on request

SPPC-PWL Connectors - Cable/Line - 1000V - 750A





CONNECTORS FOR LUG

Lug Palm Width 30mm max, Bolt Hole 10mm



Cable/Line Drain





Contacts for Lug, cable external diameter 22mm - 32mm

Color*		Short Description	Part Number
	Brown - Phase L1	SPPC-PWL-LD-L1-BR-L-OS	on request
	Black - Phase L2	SPPC-PWL-LD-L2-BK-L-OS	on request
	Grey - Phase L3	SPPC-PWL-LD-L3-GY-L-OS	on request
	Blue - Neutral	SPPC-PWL-LD-N-BU-L-OS	on request
	Green - Earth	SPPC-PWL-LD-E-GN-L-OS	on request



Cable/Line Source

Contacts for Lug, cable external diameter 22mm - 32mm

Color*		Short Description	Part Number
	Brown - Phase L1	SPPC-PWL-LS-L1-BR-L-OS	on request
	Black - Phase L2	SPPC-PWL-LS-L2-BK-L-OS	on request
	Grey - Phase L3	SPPC-PWL-LS-L3-GY-L-OS	on request
	Blue - Neutral	SPPC-PWL-LS-N-BU-L-OS	on request
	Green - Earth	SPPC-PWL-LS-E-GN-L-OS	on request



*European Harmonized Color Set, others colors set on request

SPPC-PWL Connectors - Crimping Tool

Installation Instructions:

- Select proper contacts for the copper wire size used.
- Strip the cable insulation as indicated in the table
- Insert conductor into the barrel.
- Select the proper die as indicated in the table.
- It is recommended to apply multiple crimp compressions in accordance with the above table to obtain optimum mechanical and electrical performance.

The correct sequence of compressions is shown in Fig.2.

Use the following tool:

- Hand operated crimp tool: CRT-HT131
- Cordless Hydraulic Crimp Tool: B131-C

Due to the numerous cable types available, it is recommended to contact our Customer Service to confirm cable & crimp suitability.

Cable Size	Up to 120mm ²	185mm ²	240mm ²	300mm ²	150 ÷ 185mm ²	240mm ²	240 ÷ 300mm ²
		low stranded wire			fine stranded wire		
Insulation Strip (dim L)	33mm	40mm	40mm	40mm	40mm	40mm	40mm
Recommended Number of Crimps	N/A (set screw)	1	3	3	1	3	3
Hand Operated Crimp Tool	N/A	CRT-HT120 CRT-HT131	CRT-HT120 CRT-HT131	CRT-HT120 CRT-HT131	CRT-HT120 CRT-HT131	CRT-HT120 CRT-HT131	CRT-HT120 CRT-HT131
Crimp Die Set	N/A	CDI-ME37-C	CDI-ME60-C	CDI-ME60-C	CDI-ME37-C	CDI-ME60-C	CDI-ME60-C
Contact Removal Tool	VS390038	VS390038	VS390039	VS390039	VS390038	VS390039	VS390039

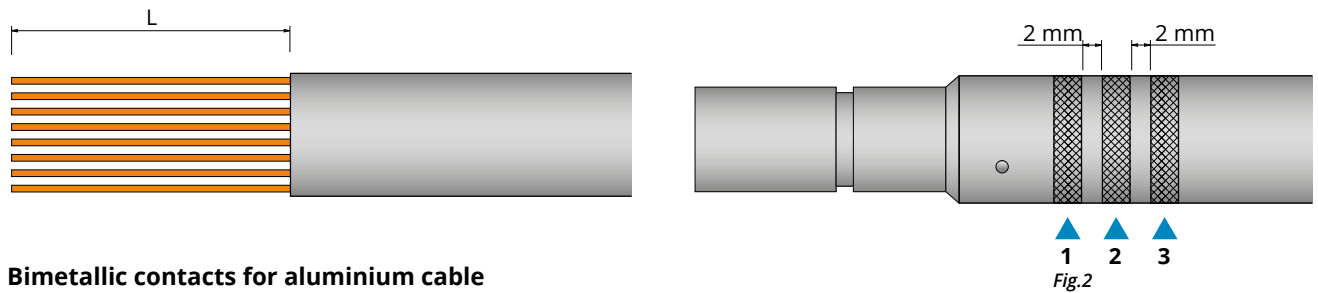

Bimetallic contacts for aluminium cable

Cable Size	70mm ²	120mm ²	150mm ²	185mm ²	240mm ²	300mm ²
	fine stranded wire					
Hand Operated Crimp Tool	***	CRT-HT120 CRT-HT131	CRT-HT120 CRT-HT131	CRT-HT120 CRT-HT131	ECW-H3D*	ECW-H3D*
Crimp Die Set	***	CDI-ME48-C	CDI-ME48-C	CDI-ME60-C	MK32-3D	MK32-3D
Contact Removal Tool	VS390039	VS390039	VS390039	VS390039	VS390460	VS390460
Recommended Number of crimp	2	2	2	2	3	3
Anti-oxidant compound**	VS390461	VS390461	VS390461	VS390461	VS390461	VS390461

* For the its operation it is necessary to combine it to a hydraulic pump

** It is recommended to cover the internal walls of the contact hole (suitable for receiving the cable conductor) with the antioxidant compound

*** Consult our sales office



Hydraulic pump ECW-H3D

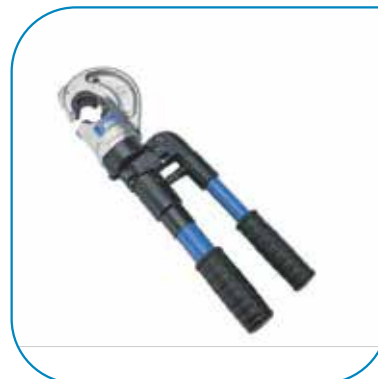

Hand Operated Crimp Tool CRT-HT131

SPPC-PWL Connectors - Removal Tool



Type	Short Description	Part Number
Screw set termination	SPPC-PWL-RT-25-120	VS390038
Crimp contacts	SPPC-PWL-RT-185-300	VS390039

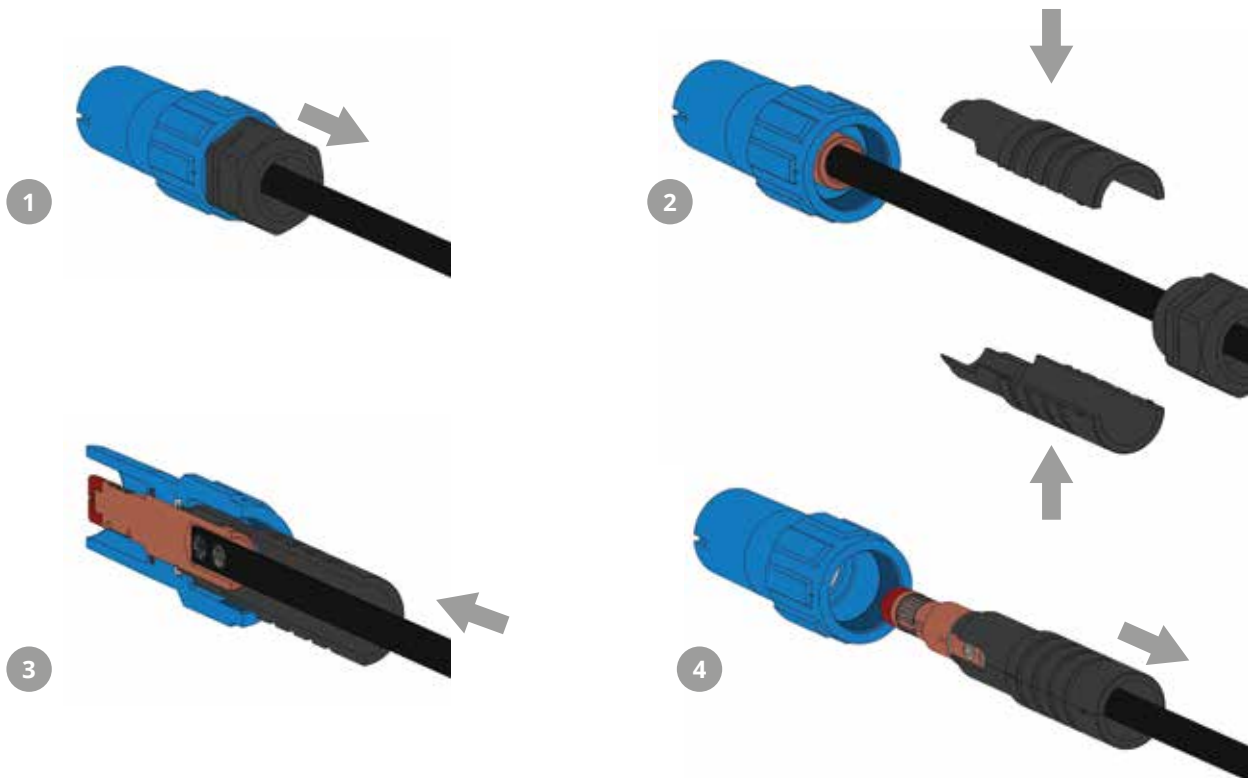

Type	Short Description	Part Number
Release Key	SPPC-PWL-KEY	VS392309

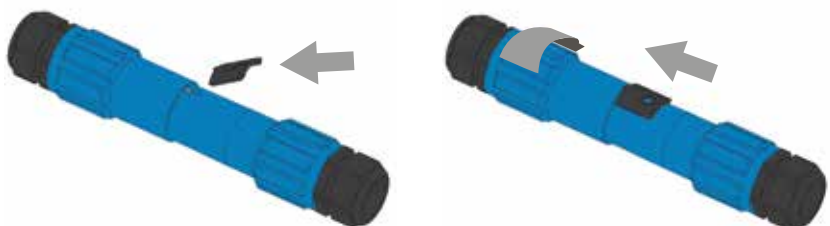

SPPC-PWL/SPPC-PWL-2.0 Connectors - Accessories



Cable Gland - for Cable/Line Connectors

Type	Short Description	Part Number
M40 threaded (19mm-28mm)	SPPC-PWL-M40	VS392301
M40 threaded (22mm-32mm)	SPPC-PWL-M40-A	VS392302
M50 threaded* (33mm-37mm)	SPPC-PWL-OS-M50	-

* To be ordered with cable/line connectors only

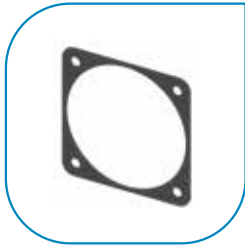

Panel Gasket

Type	Short Description	Part Number
Neoprene Gaskets	SPPC-PWL-PG	VS392308



Sleeve For Screw Contacts

Type	Short Description	Part Number
Sleeve**	SPPC-PWL-SLEEVE	VS392312

** Sleeves for cable conductor size 35 mm² - 50 mm² - 70 mm² - 95 mm² - 120 mm²



Environmental Locking Caps

Type	Short Description	Part Number
Panel SOURCE	SPPC-PWL-PS-CAP	VS392304
Panel DRAIN	SPPC-PWL-PD-CAP	VS392305
Inline SOURCE	SPPC-PWL-LS-CAP	VS392306
Inline DRAIN	SPPC-PWL-LD-CAP	VS392307



Dust Caps (on request)

Type	Short Description	Part Number
Source	SPPC-PWL-PS-LS DUST CAP	VS392313
Drain	SPPC-PWL-PD-LD DUST CAP	VS392314

SPPC-PWL Cable - Bimetallic Connectors

HOFR - N - Aluminium Cable Specifications

Cable Standards

BS 638 / Part 4

The electrical and dimensional properties of this product are measured by the Technical and Quality Assurance department. Cable performance in respect of conductor resistance, construction quality (workmanship), dimensional consistency, and other parameters are verified to published standards and approved product drawings. Conformance to RoHS (Restriction of the use of Hazardous Substances) is determined and confirmed.

Construction

Conductor	Aluminium Flexible Rope
Seperator	Polyester Foil
Insulation	EPDM (Ethylene Propylene Diene Monomer)
Outer Sheath	PCP (Polychloroprene)

Characteristics

Operating Voltage	450V / 750V
Test Voltage	3kV
Temperature Range	-20°C to +85°C
Minimum Bending Radius	10 x overall diameter
Outer Sheath Colour	Black

Dimensions

Nominal Cross Sectional Area mm ²	Nominal Diameter Of Conductor mm	Nominal Thickness of Insulation mm	Nominal Outer Diameter mm	Nominal Weight kg/km
35	7.0	0.9	14.0	190
50	8.3	0.9	16.0	320
70	10.9	0.9	17.5	400
95	12.3	1.0	20.0	520
120	14.2	1.0	23.5	560
150	16.2	1.1	24.5	690
185	17.5	1.2	27.0	880
240	22.7	1.3	32.0	1110

Electrical Characteristics

Nominal Cross Sectional Area mm ²	Electrical Resistance at 20°C mm	Permanent Current A	Voltage Drop at 85° V/A/10m
35	0.886	175	1.120
50	0.616	225	0.778
70	0.440	275	0.55
95	0.326	335	0.411
120	0.254	390	0.321
150	0.208	455	0.263
185	0.167	510	0.210
240	0.126	600	0.159





De-rating Factors

Ambient Temperature	30°C	35°C	40°C	45°C	50°C	55°C
Reduction Factor	0.96	0.91	0.87	0.82	0.76	0.71





SPPC-PWL Cable - Bimetallic Connectors



Drain-Source 16 mt

Color*		Short Description	Part Number
	Brown – Phase L1	SPPC-CA-PWL-LD-LS-L1-BR-C120-BM-16MT	VS393101
	Black – Phase L2	SPPC-CA-PWL-LD-LS-L2-BK-C120-BM-16MT	VS393105
	Grey – Phase L3	SPPC-CA-PWL-LD-LS-L3-GY-C120-BM-16MT	VS393109
	Blue – Neutral	SPPC-CA-PWL-LD-LS-N-BU-C120-BM-16MT	VS393113
	Green – Earth	SPPC-CA-PWL-LD-LS-E-GN-C120-BM-16MT	on request

Drain-Source 11 mt



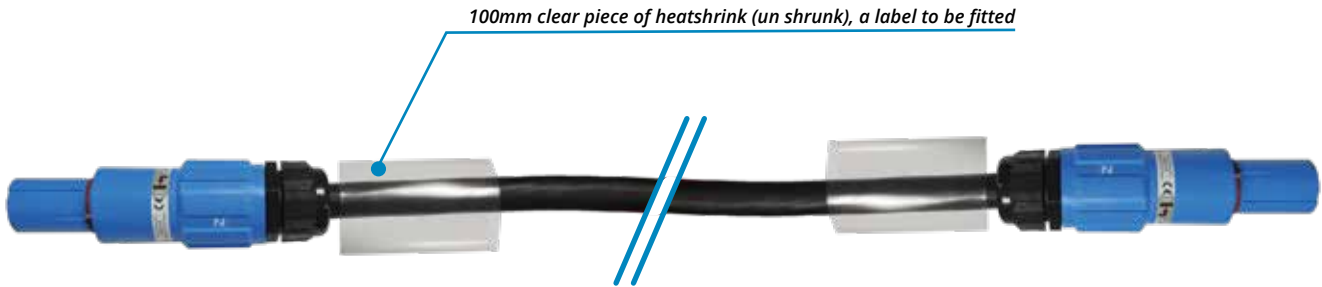

Color*		Short Description	Part Number
	Brown – Phase L1	SPPC-CA-PWL-LD-LS-L1-BR-C120-BM-11MT	VS393102
	Black – Phase L2	SPPC-CA-PWL-LD-LS-L2-BK-C120-BM-11MT	VS393106
	Grey – Phase L3	SPPC-CA-PWL-LD-LS-L3-GY-C120-BM-11MT	VS393110
	Blue – Neutral	SPPC-CA-PWL-LD-LS-N-BU-C120-BM-11MT	VS393114
	Green – Earth	SPPC-CA-PWL-LD-LS-E-GN-C120-BM-11MT	on request

**European Harmonized Color Set, others colors set on request*

SPPC-PWL Cable - Bimetallic Connectors





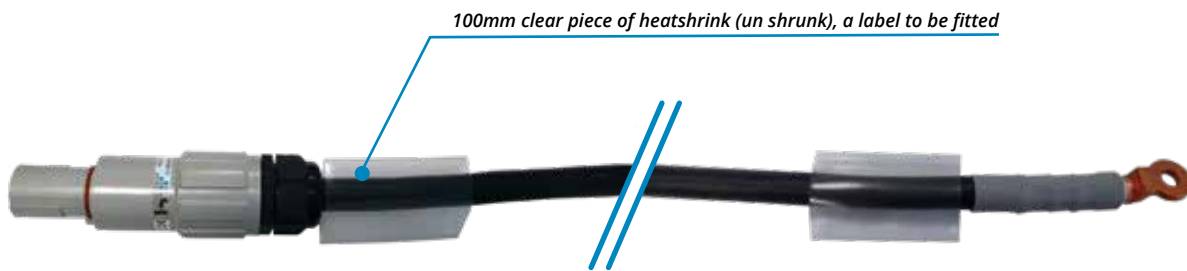

Drain-Drain 11 mt

Color*	Short Description	Part Number	
	Brown - Phase L1	SPPC-CA-PWL-LD-LD-L1-BR-C120-BM-11MT	VS393103
	Black - Phase L2	SPPC-CA-PWL-LD-LD-L2-BK-C120-BM-11MT	VS393107
	Grey - Phase L3	SPPC-CA-PWL-LD-LD-L3-GY-C120-BM-11MT	VS393111
	Blue - Neutral	SPPC-CA-PWL-LD-LD-N-BU-C120-BM-11MT	VS393115
	Green - Earth	SPPC-CA-PWL-LD-LD-E-GN-C120-BM-11MT	on request



Drain-Lug 11 mt

Color*	Short Description	Part Number	
	Brown - Phase L1	SPPC-CA-PWL-LD-CL-L1-BR-C120-BM-11MT	VS393104
	Black - Phase L2	SPPC-CA-PWL-LD-CL-L2-BK-C120-BM-11MT	VS393108
	Grey - Phase L3	SPPC-CA-PWL-LD-CL-L3-GY-C120-BM-11MT	VS393112
	Blue - Neutral	SPPC-CA-PWL-LD-CL-N-BU-C120-BM-11MT	VS393116
	Green - Earth	SPPC-CA-PWL-LD-CL-E-GN-C120-BM-11MT	on request



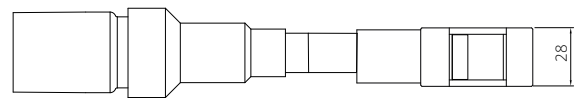
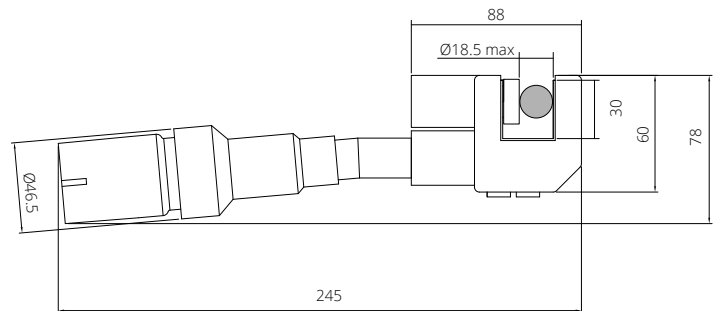

*European Harmonized Color Set, others colors set on request

SPPC-PWL Connectors - Accessories





Narrow Insulated Clamp - Short Arm



Narrow Insulated Clamp - Line Source

Color*	Short Description	Part Number
	Brown - Phase L1	SPPC-CL-PWL-LS-L1-BR VS393117
	Black - Phase L2	SPPC-CL-PWL-LS-L2-BK VS393118
	Grey - Phase L3	SPPC-CL-PWL-LS-L3-GY VS393119
	Blue - Neutral	SPPC-CL-PWL-LS-N-BU VS393120
	Green - Earth	SPPC-CL-PWL-LS-E-GN on request

Narrow Insulated Clamp - Line Drain

Color*	Short Description	Part Number
	Brown - Phase L1	SPPC-CL-PWL-LD-L1-BR on request
	Black - Phase L2	SPPC-CL-PWL-LD-L2-BK on request
	Grey - Phase L3	SPPC-CL-PWL-LD-L3-GY on request
	Blue - Neutral	SPPC-CL-PWL-LD-N-BU on request
	Green - Earth	SPPC-CL-PWL-LD-E-GN on request

*European Harmonized Color Set, others colors set on request



Tightening Tool



Short Description	Part Number
SPPC-GC-PWL-TOOL	VS393121

SPPC-PWL/SPPC-PWL-2.0 Connectors

Derating data for 85°C rubber insulated cables

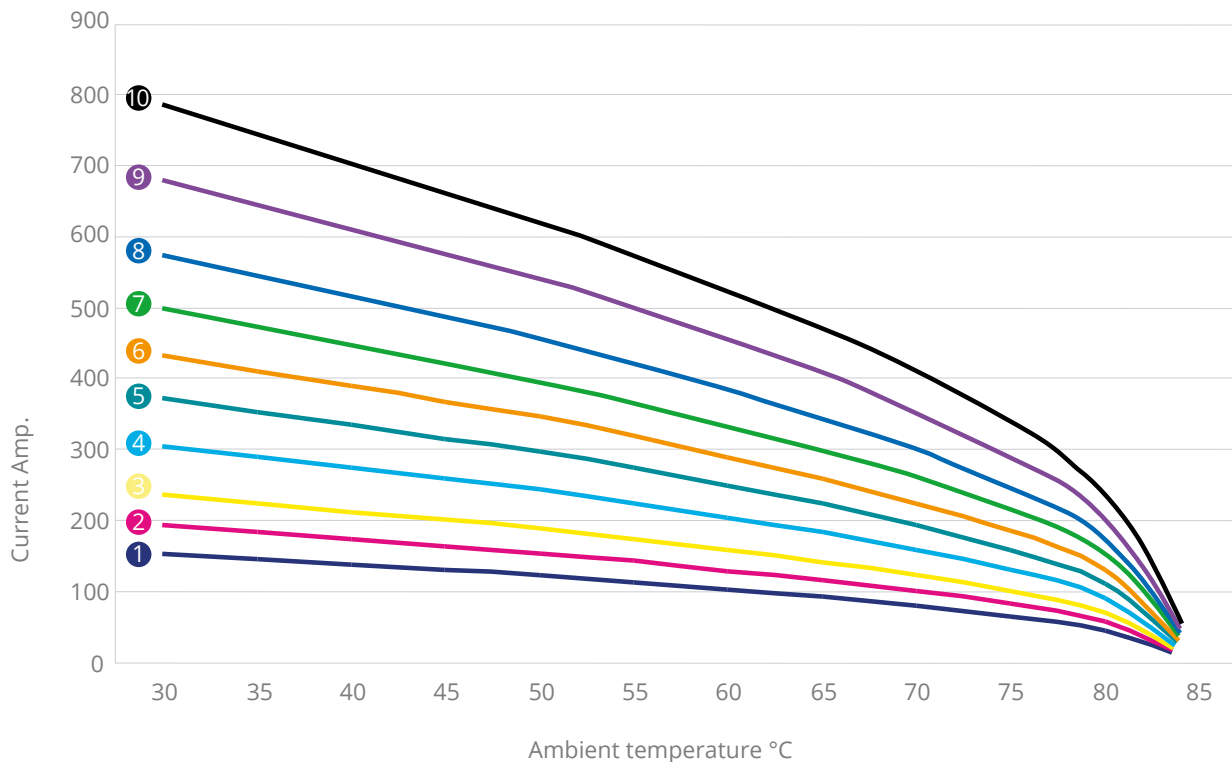

① 25mm² ② 35mm² ③ 50mm² ④ 70mm² ⑤ 95mm² ⑥ 120mm² ⑦ 150mm² ⑧ 185mm² ⑨ 240mm² ⑩ 300mm²

Characteristics

Screws Tightening Torque (in-line connectors)	12Nm
Panel Contact Tightening Torque	30Nm max
Cable Gland Tightening Torque	13Nm
Minimum Mating Cycles	500
Contact Retention in Insulator	2.5kN Axial Load
Flammability	UL94 V0
Environmental Sealing (when mated)	IP67
Rated Voltage to Earth	2000Vac
Minimum Flashover (EN60309-1)	6.8kV AC – 1 minute
Minimum Insulation Resistance	5GΩ @ 500V
Operating Voltage	1000V AC or DC
Test Voltage (Mated Condition)	5 kV- 1 minute @ 50Hz
Contact Resistance	<0.1mΩ
Short Circuit Current – 1 second	16kA
Short Circuit Current – 3 seconds	12kA
Surge Current (DIN VDE 0102/1.90)	62kA – 10mseconds
Creepage Distance	>25mm
Clearance Distance	>25mm
Temperature Range	-30°C / +125°C

S-BOX - Introduction

Sequential Box



Distribution Box for Power Connectors:

Single Pole Power Connectors have become widely adopted in a diverse range of applications and industries.

S-BOX distribution box has been developed to guarantee greater safety in use.

The connectors can only be inserted in sequence, on mating the final connector a non standard key locks the connectors in place.

The main features are:

- Polarisation system to prevent connection errors
- Up to 750 A, 1.000 V
- From 35 mm² to 300 mm² wire section
- IP67 when mated (according to EN 60529)
- Finger Protected IP2x: pin and socket contacts
- Multi-louver contact system

S-BOX - Introduction

Sequential Box

APPLICATIONS:

- Power distribution
- Utilities
- Electric Vehicles
- Railway Equipment
- Military Field Power
- Mobile Generators
- Loadbanks
- Back-up Power Systems

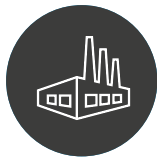

FEATURES AND BENEFITS:

- Sequential connecting ensures Ground/Earth is connected first
- Colour coding for ease of use.
- Mechanical keying to prevent incorrect mating of phases or earth and neutral.
- The metal box guarantees greater strength to mechanical shocks and resistance to mechanical shock and vibration.

Safety notice: S-Box should only be installed and operated by suitably qualified persons.



S-BOX - Introduction

Sequential Box - Features

S-BOX has been developed for use in high current installations in order to avoid disconnecting under load. Connectors are keyed and must be connected in sequence from Earth through to Line 3. The connectors can be locked and the power connected to a micro switch to ensure power flows only when everything is properly connected.



S-BOX has many security advantages if compared to individual panel connectors:

- Sequential connecting ensures ground is connected first and the non standard key locks the connectors to prevent unmating under load.
- All connectors are “keyed” to avoid cross mating.
- An M12 connector can be activated or de-activated on the locking of the non standard triangular key.
- Color coded to suit international standard.



S-BOX - Introduction

Sequential Box - Features

Fixing Holes

- Interchangeability (R 44,45 mm) modular 19".
- 2U Rack mounting (S 76,2 mm)

Robust metal frame resilient to mechanical shocks and vibration

Optional flange version with protective gasket



Sealed Caps IP65 (protection degree)

Visual indication of switch position

Finger protected IP2X: drain and source contacts.



IP2X Touch Proof protection

S-BOX - Introduction

Sequential Box - Features

The S-BOX can be supplied with different contact types:

- Threaded Post/Hole Contacts up to 150mm² - 500A / up to 300mm² - 750A.
- Crimp Contacts up to 300mm² - 750A.
- Screw Terminal Contacts up to 150mm² - 500A

Rated current: 500A (silver plated brass contacts) - 750A (silver plated copper contacts)



External grounding contacts

M12 connector internally wired with microswitch

M12 Threaded hole

M12 Threaded post

Rear adaptor with M40 Cable Gland



Screw terminal

Crimp contacts

S-BOX - Introduction

Sequential Box - Features

An optional backshell and cable gland gives IP67 protection at the rear (for use with screw terminal or crimp contacts).



The S-BOX may be mounted into standard modular 19" rack systems or in panel mounts.

Using sealing caps does not alter the height. One box can be mounted directly above another.



S-BOX - Introduction

Sequential Box

SEQUENTIAL BOX OPERATING INSTRUCTIONS:

Connection of Sequential Box connectors is made sequentially, starting with Ground / Earth connection (Green) and working to the right.

- Insert the Ground (Green) connector, aligning the Plug connector arrow on the label of the connector in a 12 o'clock position. Fully insert the connector until it bottoms out and turn until the connector stops.
- Repeat for the Neutral connector, followed in order by L1, L2, and L3.
- Lock the connectors, using the triangular drive key provided, the lock is situated adjacent to the L3 connection.
- Remove the key. All connectors are now locked in place and can be removed only when the box is unlocked.
- The power must be turned off and reverse the above procedure, to remove the connectors.

1

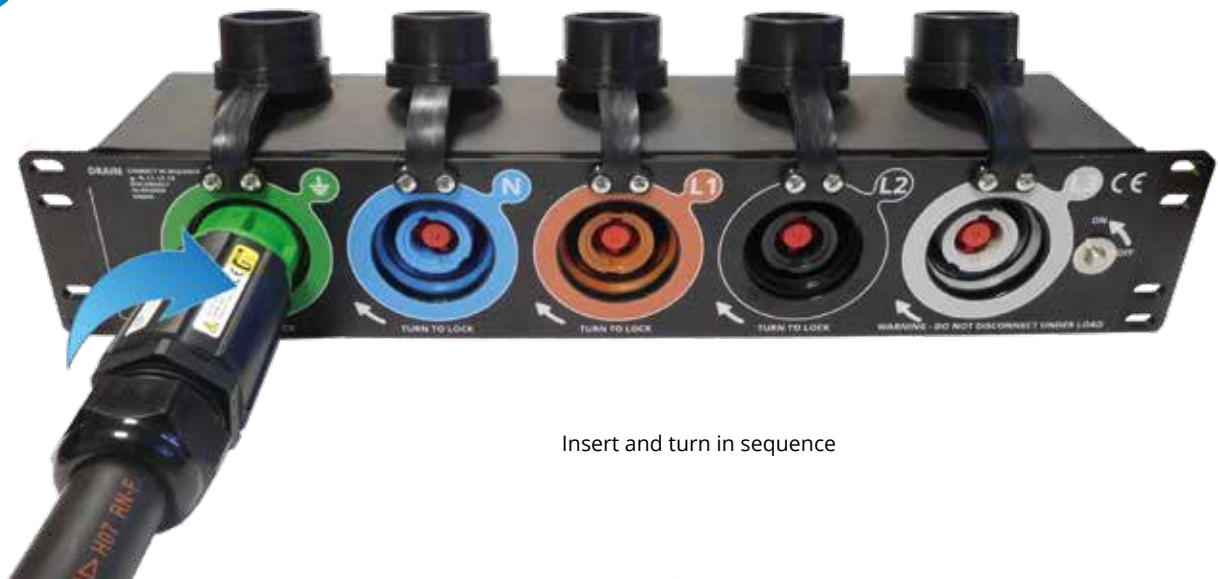

Insert and turn in sequence

2



The last connector lock the previous one

S-BOX - Introduction

Sequential Box

3

Lock the connectors and switch on the microswitch by locking using the triangular key.



You can use the SPPC-PWL2.0 connectors and the SPPC-PWL connectors as well as compatible versions.



S-BOX - Introduction

Sequential Box

M12 CONNECTOR:

3 Pole M12 is located on the rear of the unit to provide a remote monitoring function of equipment status but it cannot be the only safety guarantee.

The M12 connector installed on the rear is connected to a microswitch inside the unit, the microswitch is activated using the triangular key.

The connector body has 4 poles with 3 contacts wired to the switch. Using 3 poles, the cable connector can be wired to suit your requirements, either "Normally Open" or "Normally Closed" or both.

The microswitch cannot be used to switch off the voltage power.

Do not disconnect under load.



Contact Position	ON	OFF
1	Common	Common
2	Open	Closed
3	Closed	Open
4	Not Used	Not Used

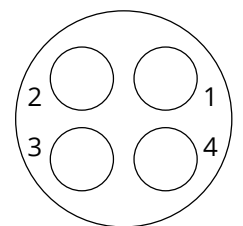

PACKAGING:

The carton box and internal packing are recyclable and should be disposed of separately.

PACKAGING CONTENTS:

The packaging contains the following components:

QTY	COMPONENTS
1	Sequential Box
3 or 5	SPPC Contacts (according to the number of connectors)
1	Triangular key
1	3 pole M12 cable connector
1	Operating / Maintenance guide

S-BOX - Introduction

Sequential Box

CHARACTERISTICS:

Current rating	500A or 750A (check label for rating)
Voltage rating	1000V
Microswitch operating voltage	250Vac / 30Vdc max.
Microswitch current rating	4A (Resistive Load) / 0,5A (Lamp Load)
Operating temperature	-30°C to +85°C
Environmental protection	IP67 (when mated connectors and locked) IP65 (when caps are closed) IP2X (finger protected)
Sequential Box weight	Unit with rubber caps: 4.70 Kg approx Unit without caps: 4.35 Kg approx
Flammability rating	UL94-V0
Endurance	500 connection cycles

ELECTRICAL INSTALLATION:

The connection to back of the unit is:

- Threaded Post/Hole Contacts up to 150mm² - 500A / up to 300mm² - 750A.
- Crimp Contacts up to 300mm² - 750A.
- Screw Terminal Contacts up to 150mm² - 500A

SAFETY PRECAUTIONS:

- Use the connectors and connected cables within their electrical and environmental limits
- Each position is marked on the front of the box, E (Ground), N, L1, L2, & L3 (or +,-).
- The threaded post contacts have a spring washer and nut that should be tightened to a torque of 30Nm max.
- The screw terminal contacts should be tightened to a torque of 12Nm max.
- Cable connections: Threaded Post/Hole on the rear of the unit are for connecting power cables fitted with cable lugs.
- It is recommended that insulated spanners and correct tools are used when making the connections and installations.
- The shell of S-Box must be connected to the rear ground connection (M6).
- After wiring it is necessary to verify the continuity of the protective earth connections.

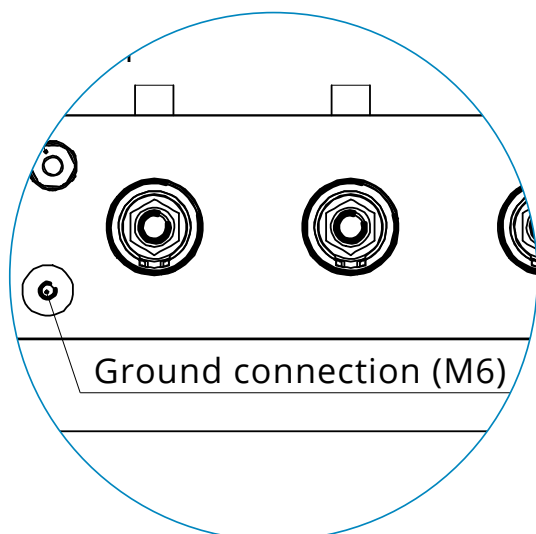

S-BOX - Dimensions

Panel Drain Connectors

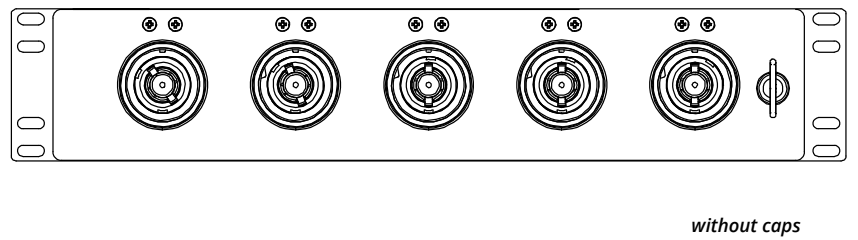
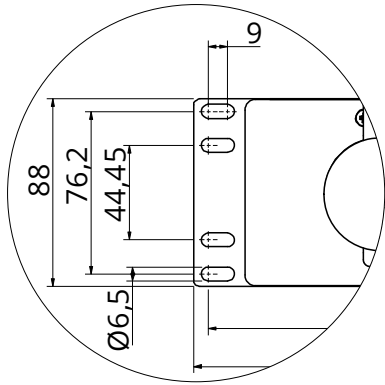
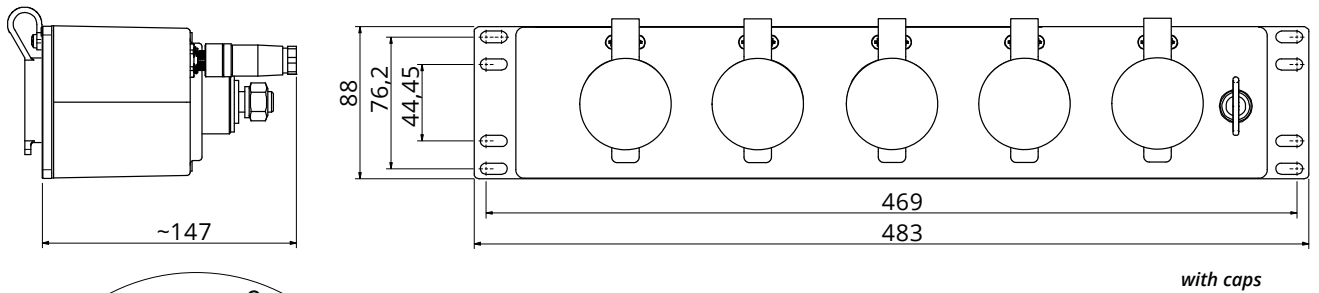

M12 Threaded post version

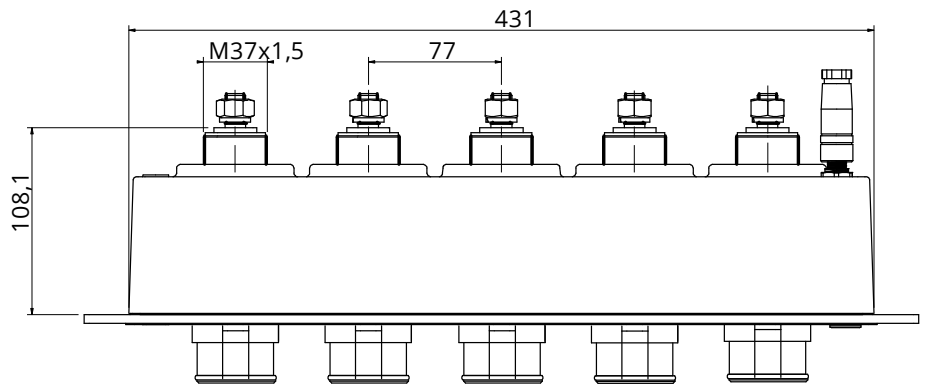

M12 Threaded hole post version

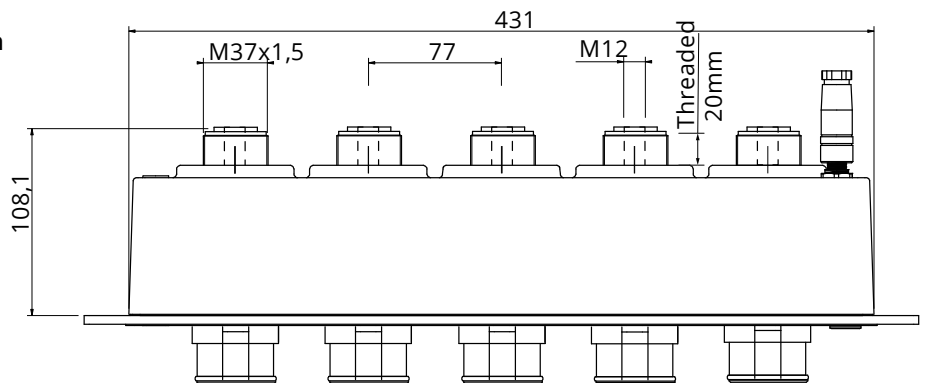

Dimension in mm

S-BOX - Dimensions

Panel Source Connectors

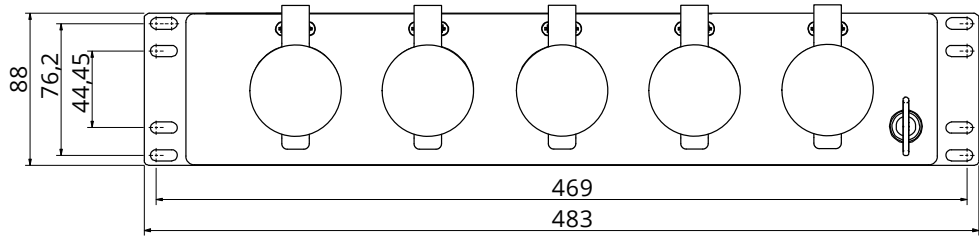
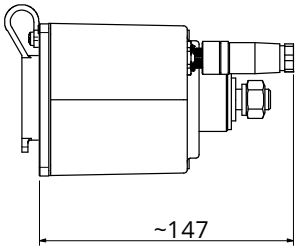

with caps

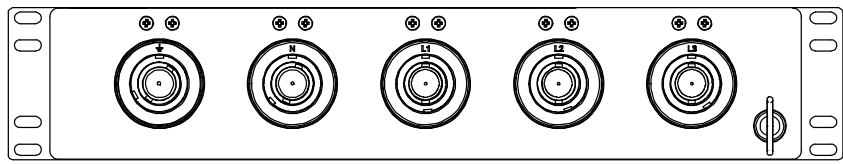
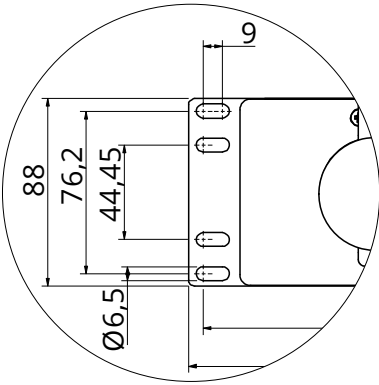

without caps

M12 Threaded post version

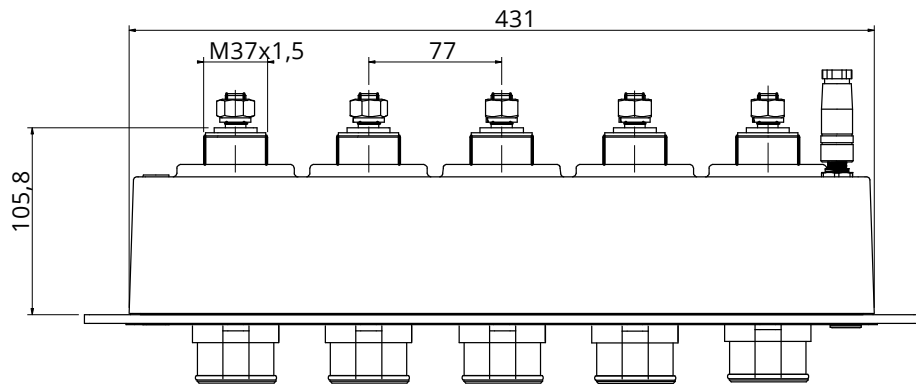

M12 Threaded hole post version

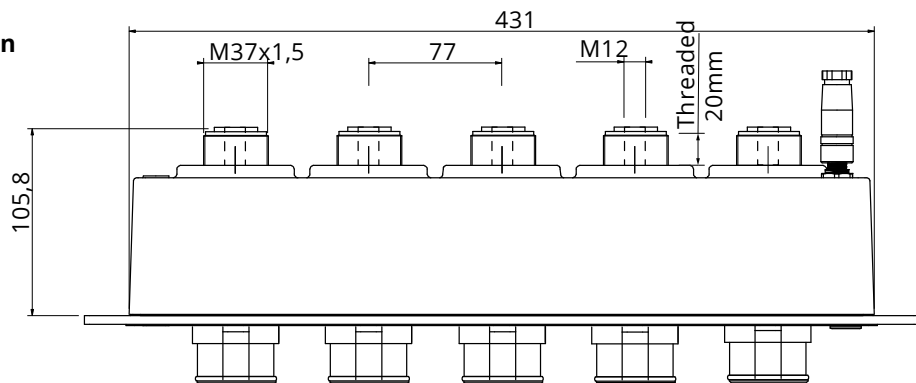

Dimension in mm

S-BOX - Dimensions - Flanged Version

Panel Drain Connectors

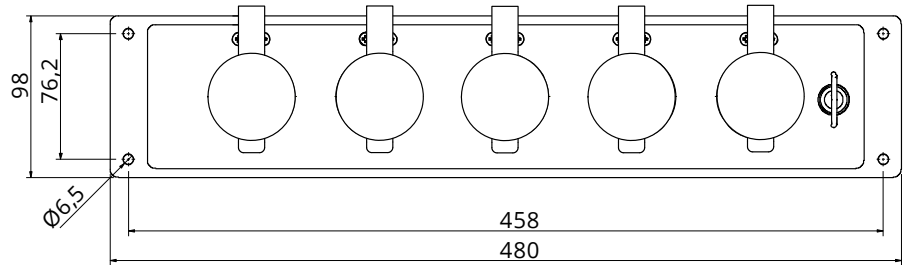
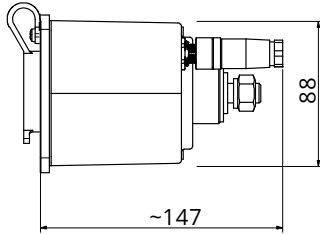

with caps

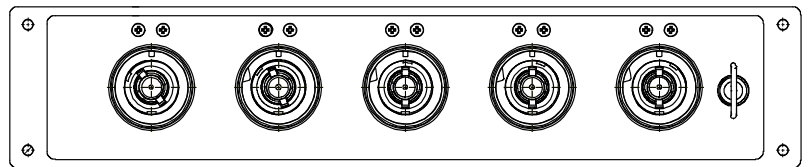

without caps

M12 Threaded post version

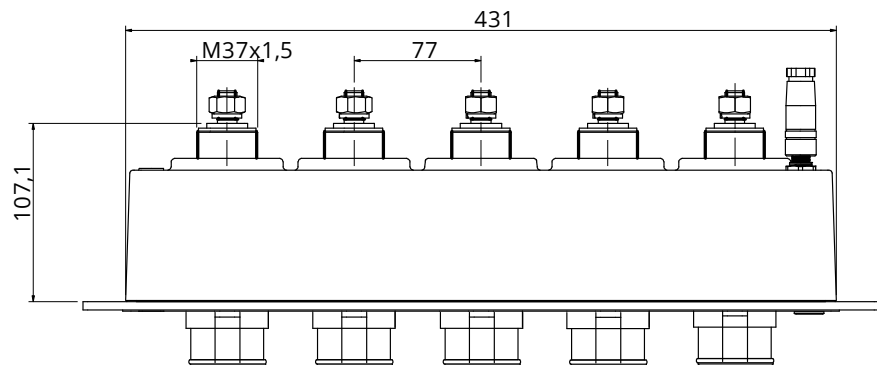

M12 Threaded hole post version

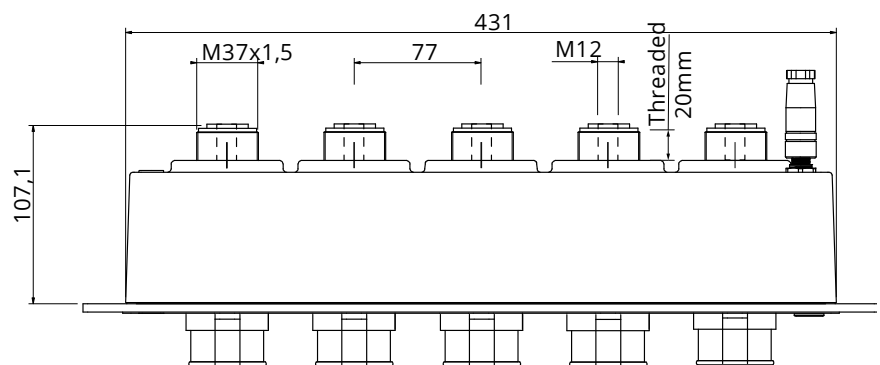

Dimension in mm

S-BOX - Dimensions - Flanged Version

Panel Source Connectors

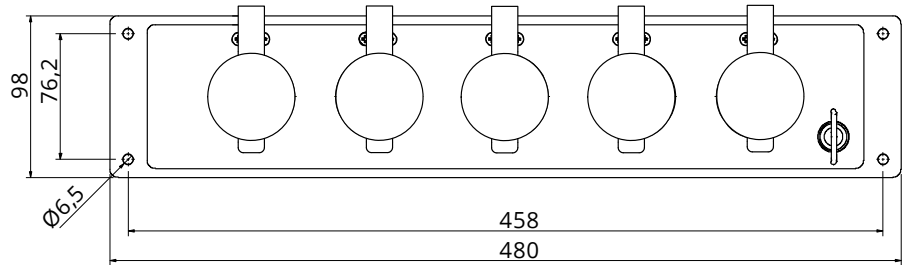
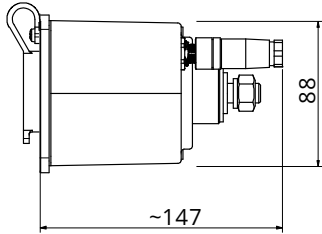

with caps

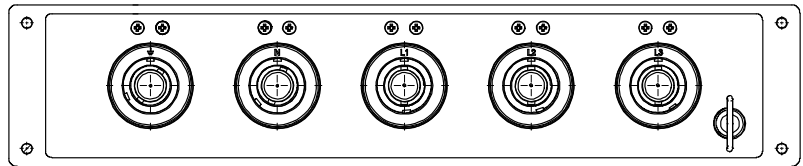

M12 Threaded post version

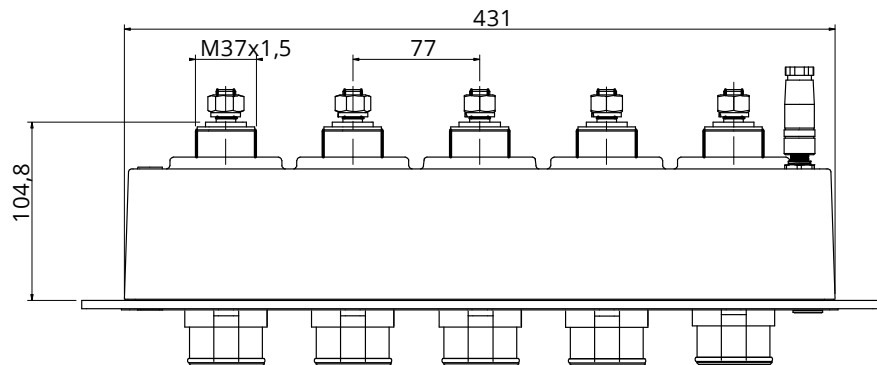

M12 Threaded hole post version

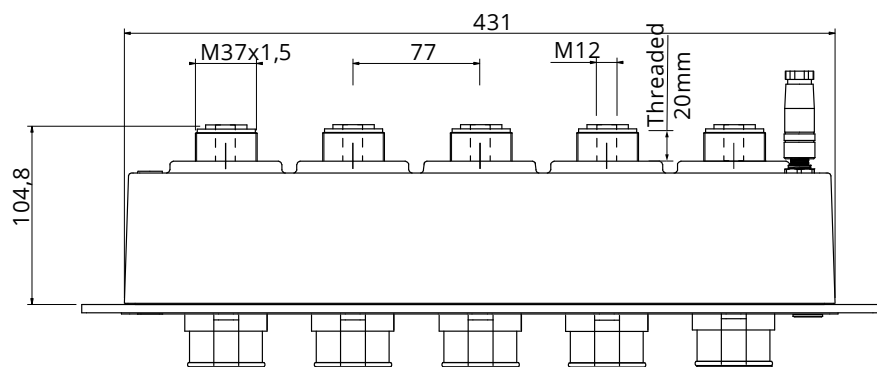

Dimension in mm

S-BOX - Mounting Instructions

Attention: ensure the unit is adequately supported during mounting / dismantling and in normal use.

It is recommended that M6 screws/bolts and flat washers are used, and tightened to a recommended torque (check it with the screws/bolts manufacturer).

PANEL CUT OUT FOR FLANGED TYPE:

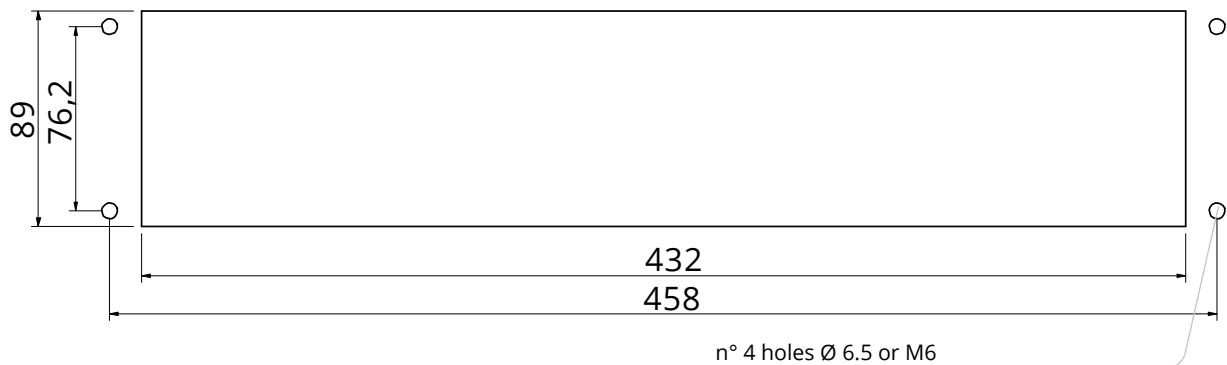

M12 connector

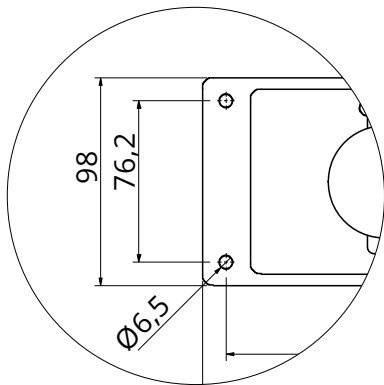
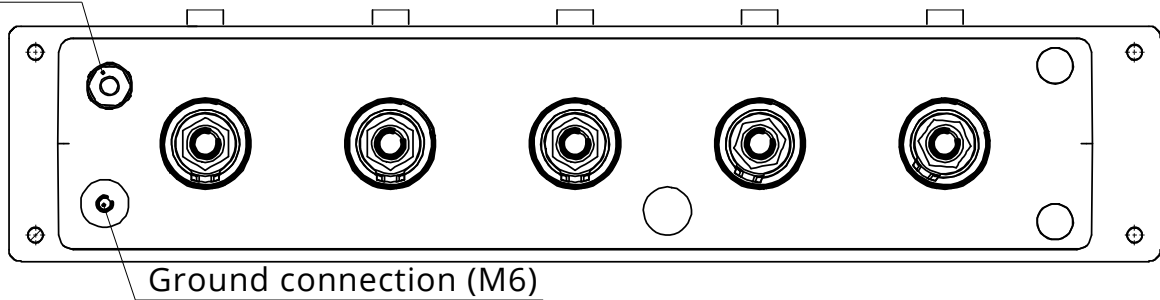

S-BOX - Part number explanation

SPPC-SB

PD

EU









L

TH7

P/N Sample: SPPC-SB-PD-EU-L-TH7

SPPC-SB	Series Code	SPPC-SB	Single Pole Power connectors - Sequential Box
PD	Connector Type	PS	Panel Source
		PD	Panel Drain
EU	Insulator color	EU	European 5 Connectors (3P+N+E)
		EU4	European 4 Connectors (3P+E)
		DC	Direct current
L	Caps	-	Without caps
		L	With rubber caps
TH7	Contact Termination	M12-T7	M12 Threaded post - 750A
		M12-T4	M12 Threaded post - 500A
		S-120	Screw terminal - 500A up to 150mm ² (Maximum diameter 16.5mm)
		C-35	Crimp contacts - 500A 35mm ²
		C-50	Crimp contacts - 500A 50mm ²
		C-70	Crimp contacts - 500A 70mm ²
		C-95	Crimp contacts - 500A 95mm ²
		C-120	Crimp contacts - 500A 120mm ²
		C-150	Crimp contacts - 500A 150mm ²
		C-185	Crimp contacts - 750A 185mm ²
		C-240	Crimp contacts - 750A 240mm ²
		C-300	Crimp contacts - 750A 300mm ²
		TH7	Threaded hole - 750A
		TH4	Threaded hole - 500A
PM	Mounting Type	-	Modular 19" rack version
		PM	Panel mounting

COLOUR CODING

Standard	Earth	Neutral	Phase L1	Phase L2	Phase L3
Europe	Green (GN) 	Blue (BU) 	Brown (BR) 	Black (BK) 	Grey (GY) 
Direct current DC	Green (GN) 	Black (BK) 	-	Red (RD) 	-

S-BOX - Panel Drain Connectors with rubber caps



*European Harmonized Color Set, others colors set on request



750A

M12 Threaded post, copper contacts

Color*	Short Description	Part Number	
European	SPPC-SB-PD-EU-L-M12-T7	VS398905	 Certified

500A

M12 Threaded post, brass contacts

Color*	Short Description	Part Number	
European	SPPC-SB-PD-EU-L-M12-T4	VS398906	 Certified



750A

M12 Threaded hole, copper contacts

Color*	Short Description	Part Number	
European	SPPC-SB-PD-EU-L-TH7	VS398901	 Certified

500A

M12 Threaded hole, brass contacts

Color*	Short Description	Part Number	
European	SPPC-SB-PD-EU-L-TH4	VS398902	 Certified

S-BOX - Panel Source Connectors with rubber caps



*European Harmonized Color Set, others colors set on request



750A M12 Threaded post, copper contacts

Color*	Short Description	Part Number	
European	SPPC-SB-PS-EU-L-M12-T7	VS398907	 Certified

500A M12 Threaded post, brass contacts

Color*	Short Description	Part Number	
European	SPPC-SB-PS-EU-L-M12-T4	VS398908	 Certified



750A M12 Threaded hole, copper contacts

Color*	Short Description	Part Number	
European	SPPC-SB-PS-EU-L-TH7	VS398903	 Certified

500A M12 Threaded hole, brass contacts

Color*	Short Description	Part Number	
European	SPPC-SB-PS-EU-L-TH4	VS398904	 Certified

S-BOX - Panel Drain Connectors with rubber caps - Flanged Version

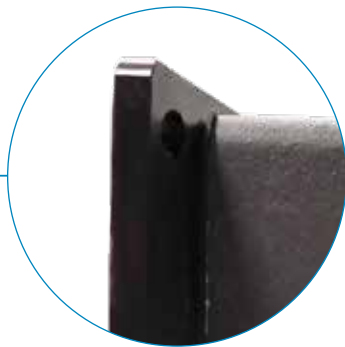

**European Harmonized Color Set, others colors set on request*



750A M12 Threaded post, copper contacts

Color*	Short Description	Part Number	
European	SPPC-SB-PD-EU-L-M12-T7-PM	VS398911	 Certified

500A M12 Threaded post, brass contacts

Color*	Short Description	Part Number	
European	SPPC-SB-PD-EU-L-M12-T4-PM	VS398917	 Certified



750A M12 Threaded hole, copper contacts

Color*	Short Description	Part Number	
European	SPPC-SB-PD-EU-L-TH7-PM	VS398918	 Certified

500A M12 Threaded hole, brass contacts

Color*	Short Description	Part Number	
European	SPPC-SB-PD-EU-L-TH4-PM	VS398919	 Certified

S-BOX - Panel Source Connectors with rubber caps - Flanged Version



*European Harmonized Color Set, others colors set on request



750A M12 Threaded post, copper contacts

Color*	Short Description	Part Number	
European	SPPC-SB-PS-EU-L-M12-T7-PM	VS398920	 Certified

500A M12 Threaded post, brass contacts

Color*	Short Description	Part Number	
European	SPPC-SB-PS-EU-L-M12-T4-PM	VS398921	 Certified



750A M12 Threaded hole, copper contacts

Color*	Short Description	Part Number	
European	SPPC-SB-PS-EU-L-TH7-PM	VS398922	 Certified

500A M12 Threaded hole, brass contacts

Color*	Short Description	Part Number	
European	SPPC-SB-PS-EU-L-TH4-PM	VS398915	 Certified

S-BOX Connectors - Accessories



Rear Adapter with M40 Cable Gland

Wire section	Short Description	Part Number
19mm – 28mm	SPPC-SB-CG-M	On Request
22mm – 32mm	SPPC-SB-CG-OS	On Request

Can be used with screw terminal and crimp contacts only



Caps

	Short Description	Part Number
for S-BOX panel drain	SPPC-SB-PD-L	On Request
for S-BOX panel source	SPPC-SB-PS-L	On Request

S-BOX Connectors

Reference Data for Cable Selection

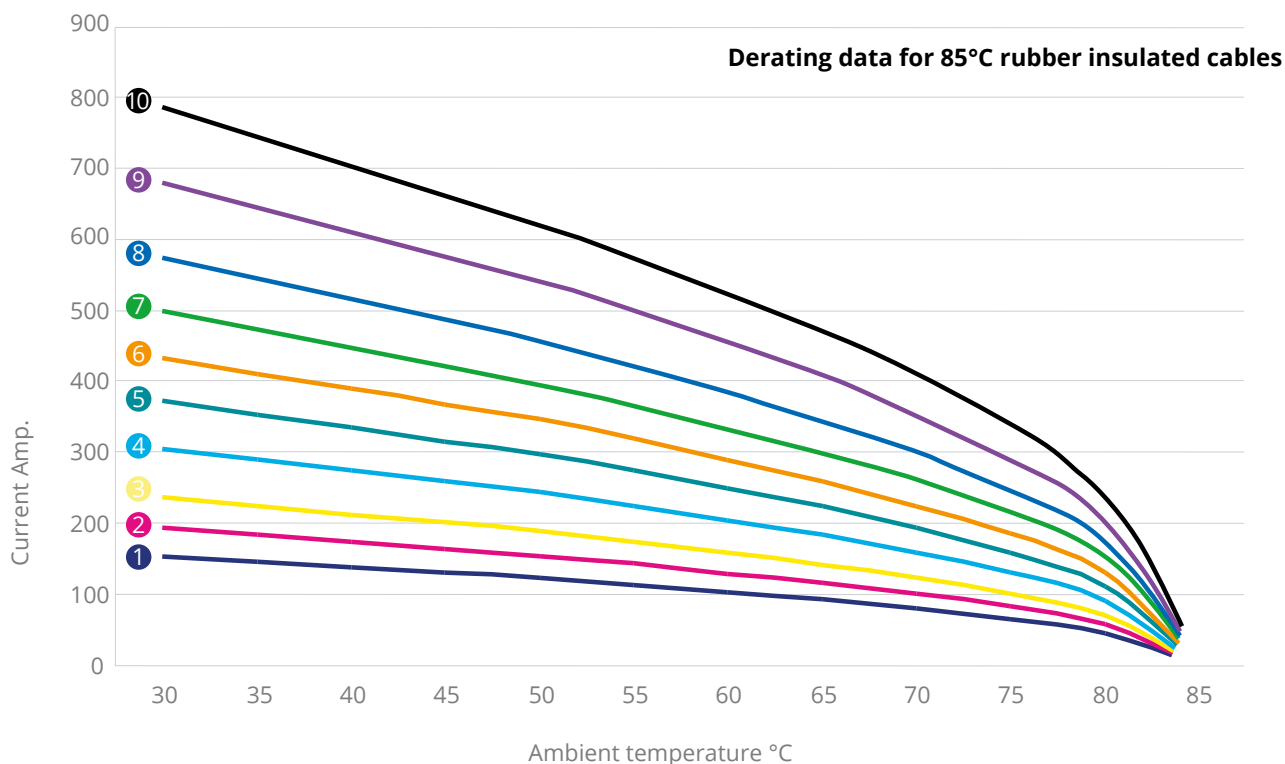

- ① 25mm² ② 35mm² ③ 50mm² ④ 70mm² ⑤ 95mm² ⑥ 120mm² ⑦ 150mm² ⑧ 185mm² ⑨ 240mm² ⑩ 300mm²

Characteristics

Screws Tightening Torque (in-line connectors)	12Nm
Panel Contact Tightening Torque	30Nm max
Cable Gland Tightening Torque	13Nm
Minimum Mating Cycles	500
Contact Retention in Insulator	2.5kN Axial Load
Flammability	UL94 V0
Environmental Sealing (when mated)	IP67
Rated Voltage to Earth	2000Vac
Minimum Flashover (EN60309-1)	6.8kV AC – 1 minute
Minimum Insulation Resistance	5GΩ @ 500V
Operating Voltage	1000V AC or DC
Test Voltage (Mated Condition)	5 kV- 1 minute @ 50Hz
Contact Resistance	<0.1mΩ
Short Circuit Current – 1 second	16kA
Short Circuit Current – 3 seconds	12kA
Surge Current (DIN VDE 0102/1.90)	62kA – 10mseconds
Creepage Distance	>25mm
Clearance Distance	>25mm
Temperature Range	-30°C / +125°C

S-BOX Connectors - Crimping Tool

Installation Instructions:

- Select proper contacts for the copper wire size used.
- Strip the cable insulation as indicated in the table
- Insert conductor into the barrel.
- Select the proper die as indicated in the table.
- It is recommended to apply multiple crimp compressions in accordance with the above table to obtain optimum mechanical and electrical performance.

The correct sequence of compressions is shown in Fig.2.

Use the following tool:

- Hand operated crimp tool: HT131-C
- Cordless Hydraulic Crimp Tool: B131-C

Due to the numerous cable types available, it is recommended to contact our Customer Service to confirm cable & crimp suitability.

Cable Size	Up to 120mm ²	185mm ²	240mm ²	300mm ²	150 ÷ 185mm ²	240mm ²	240 ÷ 300mm ²
		low stranded wire			fine stranded wire		
Insulation Strip (dim L)	33mm	40mm	40mm	40mm	40mm	40mm	40mm
Recommended Number of Crimps	N/A (set screw)	1/2	3	3	1/2	3	3
Hand Operated Crimp Tool	N/A	HT120 HT131-C	HT120 HT131-C	HT120 HT131-C	HT120 HT131-C	HT120 HT131-C	HT120 HT131-C
Crimp Die Set	N/A	ME37-C (1) ME48-C (2)	ME60-C	ME60-C	ME37-C (1) ME48-C (2)	ME60-C	ME60-C
Contact Removal Tool	VS390038	VS390039	VS390039	VS390039	VS390039	VS390039	VS390039

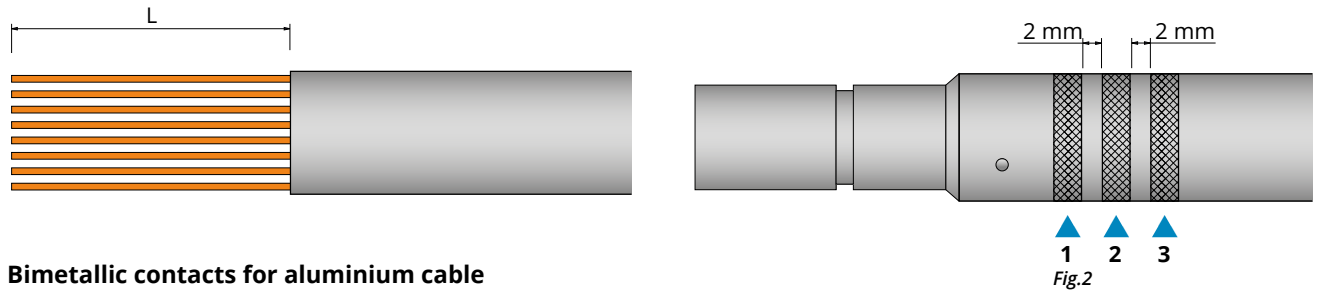

Bimetallic contacts for aluminium cable

Cable Size	70mm ²	120mm ²	150mm ²	185mm ²	240mm ²	300mm ²
	fine stranded wire					
Hand Operated Crimp Tool	***	HT120 HT131-C	HT120 HT131-C	HT120 HT131-C	ECW-H3D*	ECW-H3D*
Crimp Die Set	***	ME48-C	ME48-C	ME60-C	MK32-3D	MK32-3D
Contact Removal Tool	VS390039	VS390039	VS390039	VS390039	VS390460	VS390460
Recommended Number of crimp	2	2	2	2	3	3
Anti-oxidant compound**	VS390461	VS390461	VS390461	VS390461	VS390461	VS390461

* For the its operation it is necessary to combine it to a hydraulic pump

** It is recommended to cover the internal walls of the contact hole (suitable for receiving the cable conductor) with the antioxidant compound

*** Consult our sales office



Hydraulic pump ECW-H3D



Hand Operated Crimp Tool HT131-C

S-BOX Connectors - Removal Tool



Type	Short Description	Part Number
Screw set termination	SPPC-PWL-RT-25-120	VS390038
Crimp contacts	SPPC-PWL-RT-185-300	VS390039

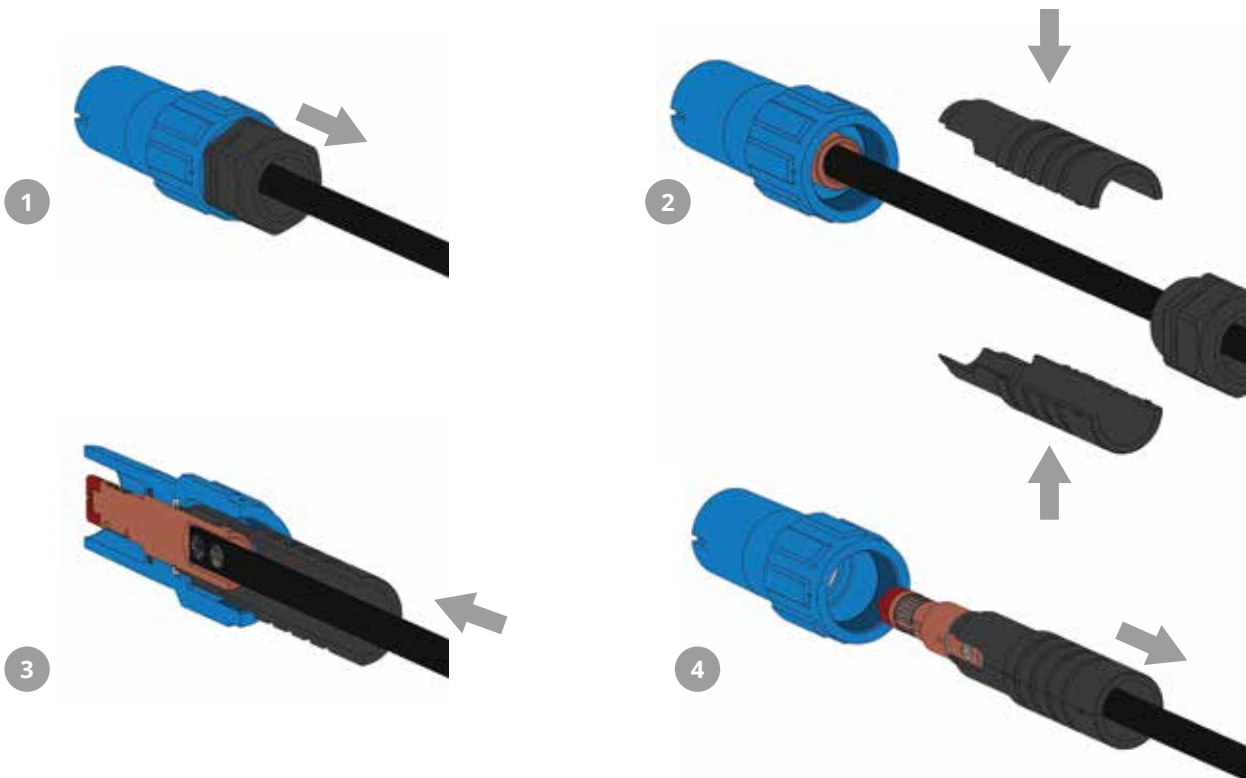

S-BOX Connectors - Special Version

Other Versions are supplied on request:

- DC



- AC: 3 Poles + Earth (EU4)



SPPC-HK Connectors - Introduction

Single Pole Power Connector up to 400A



HOOK series offers new opportunities of using the electrical connection even in applications where in the past this was not possible due to low cost requirements and without renouncing to a complete range of features concerning robustness, reliability and safety.

APPLICATIONS:

- Power distribution
- Utilities
- Electric Vehicles
- Railway Equipment
- Military Field Power
- Mobile Generators
- Loadbanks
- Back-up Power Systems

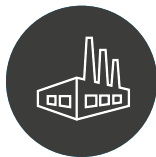

SPPC-HK Connectors - Introduction

Single Pole Power Connector up to 400A

KEY CHARACTERISTICS

- brass contacts for current up to 250A and cable section from 16 to 70 mm² or from 4 to 2/0AWG
- copper contacts for current up to 400A and cable section from 95 to 120 mm² or for 4/0AWG
- 500 mating cycles minimum
- IP67 sealed when mated
- EN/ESI compliant creepage and clearance distances
- UL 94V0 flame retardant insulating material
- EN/CE compliant metric cable glands
- Cable sizes from 16 to 120 mm² or from 4 to 4/0 AWG
- Set screw and crimp contact versions
- Multi-louver contact version
- CE compliant

Drain cable connectors are typically used as the live or supply side of the circuit. They are finger protected in the un-mated condition to meet the requirements IP2X. They protect the user from accidental contact with any live elements.

Source cable connectors are typically used as the load side of the circuit.

The cable connectors are either available:

- With set screw terminal (with or without crimping sleeves) for cable section from 16 to 70 mm² or from 4 to 2/0AWG
- With crimp termination for cable sections up to 120 mm² or for 4/0AWG

A plastic water tight strain relief is supplied to provide IP67 sealing.

Drain panel connector are typically used as the live or supply side of the circuit. They are finger protected in the un-mated condition to meet the requirements IP2X.

Source panel connectors are typically used as the load side of the circuit.

Panel connectors can be either front or rear mounted on equipment while maintaining EN/ESI creepage and clearance distances, and are supplied in brass material (up to 250A) or in copper material (up to 400A) versions. These connectors have M12 threaded post termination and are supplied with pre-installed contacts.

SPPC-HK Connectors - Introduction

Single Pole Power Connector up to 400A

POWER CONNECTORS TYPES:

- **Source: Socket** connector is the source of the power, it receives and holds the Pin connector.
- **Drain: Pin** connectors receives and holds the Socket connector.
- **Cable/line: source (1) or drain (2)** is a moveable connectors fitted to a cable. The contacts are available in crimp or screw terminal.
- **Panel: source (3) or drain (4)** receptacle connectors to be fixed to a panel.

Power connectors cannot be mated/unmated under voltage or underloaded.

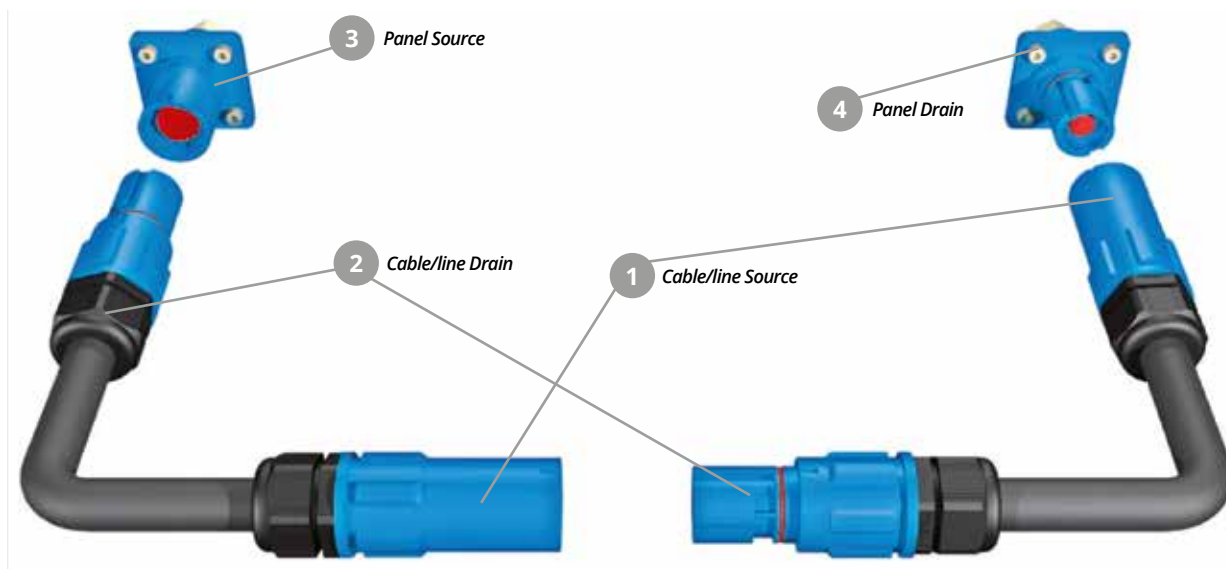

MECHANICALLY KEYED TO PREVENT CONNECTION ERRORS

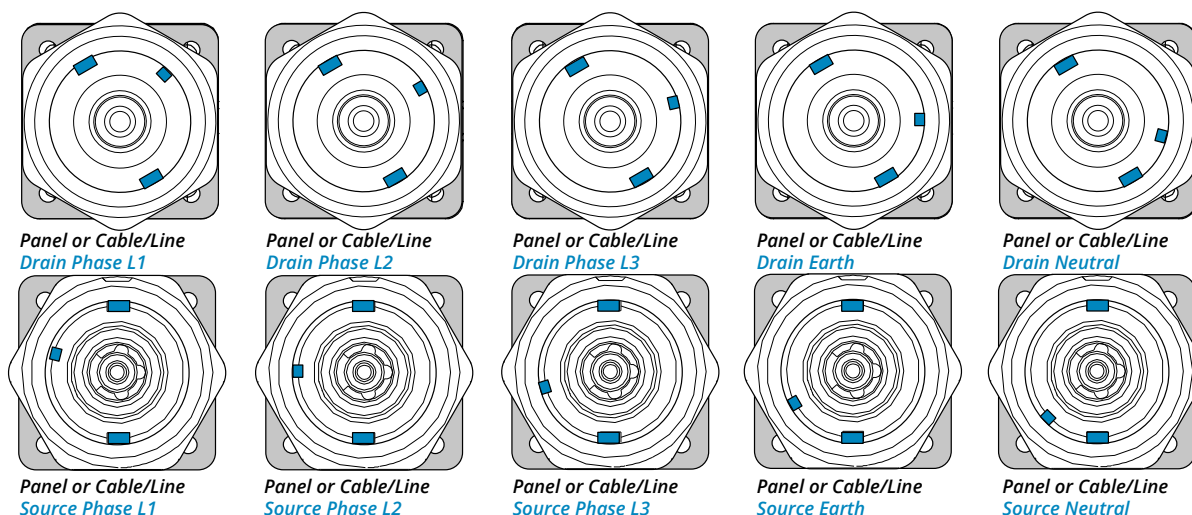





COLOUR CODING.

Standard	Phase L1	Phase L2	Phase L3	Earth	Neutral
Europe	Brown (BR) 	Black (BK) 	Grey (GY) 	Green (GN) 	Blue (BU) 

SPPC-HK Connectors - Part number explanation



P/N Sample: SPPC-HK-LS-L1-BR-C-120-M

SPPC-HK	Series Code	SPPC-HK	Single Pole Power Connectors
LS	Connector Type	LS	Cable/Line Source
		LD	Cable/Line Drain
		PS	Panel Source
		PD	Panel Drain
L1	Key Position	E	Earth
		N	Neutral
		L1	Phase 1
		L2	Phase 2
BR	Insulator Color	L3	Phase 3
		BR	 Brown
		BK	 Black
		GY	 Grey
		BU	 Blue
C-240	Contact Termination	GN	 Green
		M12-T2	M12 Threaded post - 250A
		M12-T4	M12 Threaded post - 400A
		S-70	Screw terminal - 250A up to 70mm ²
		C-70	Crimp contacts - 250A 70mm ²
M	Cable External diameter	C-120	Crimp contacts - 400A 95mm ² - 120mm ²
		S	7mm - 15mm
		M	11mm - 21mm
	Microswitch	OS	18mm - 25mm
		-	without microswitch
		SW	with normally open microswitch
	Customization	SWC	with normally closed microswitch

SPPC-HK Connectors - Introduction

Hook Mating System: a faster and more reliable connection

- Position major key alignment arrows
- Firmly push the Pin and Socket connectors together
- Rotate the Pin and Socket connectors in opposite direction until the padlock symbol is in alignment with the arrow symbol
- Release the connectors and they spring into the locked position.
- To unlock, push the connectors firmly together, rotate in opposite directions and pull apart

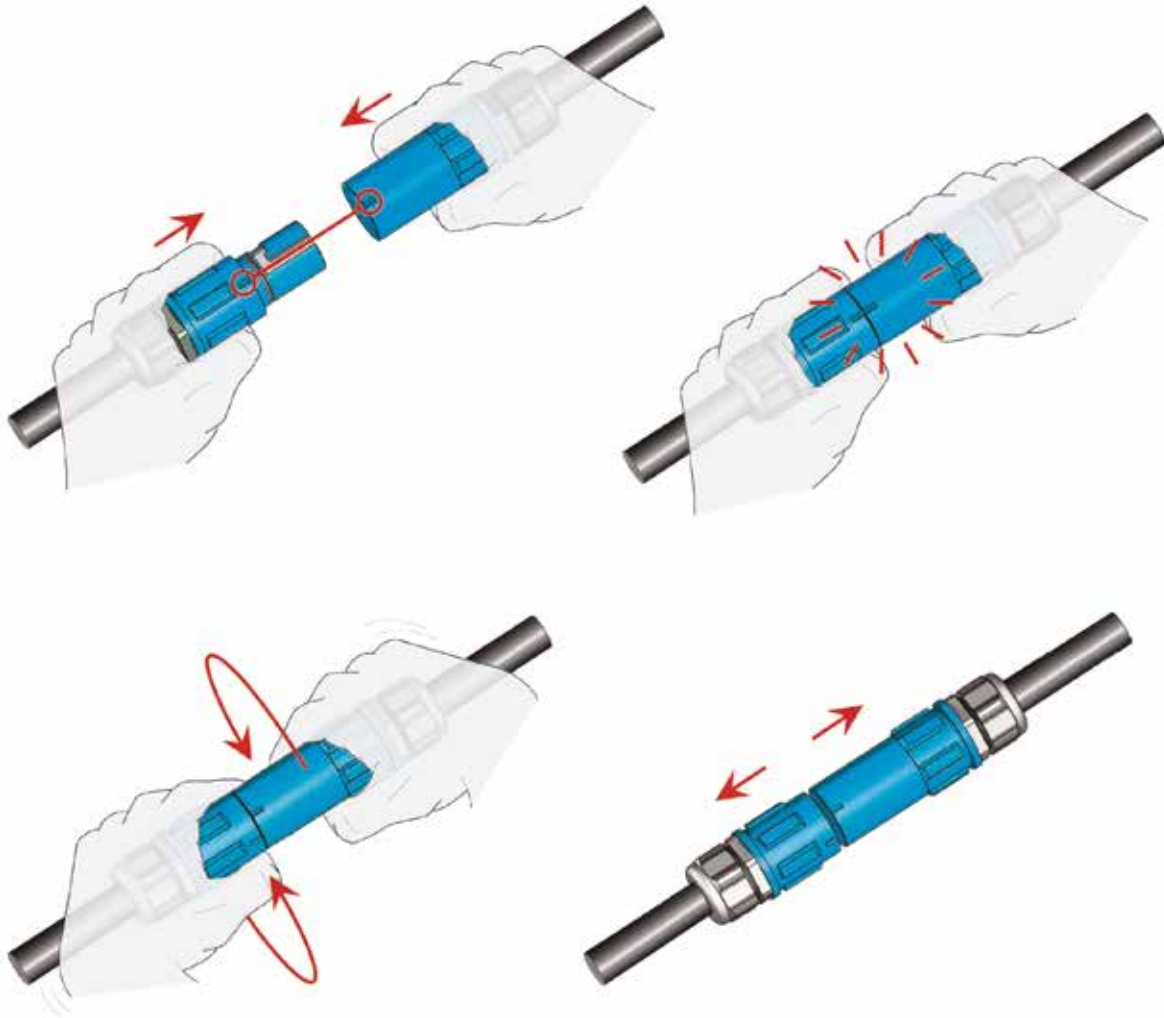

Unwanted uncoupling prevention: a simple cable tie makes the system safer.

The connectors can only be separated by removing it with a suitable tool.



SPPC-HK Connectors - Dimensions

Panel Source Connectors

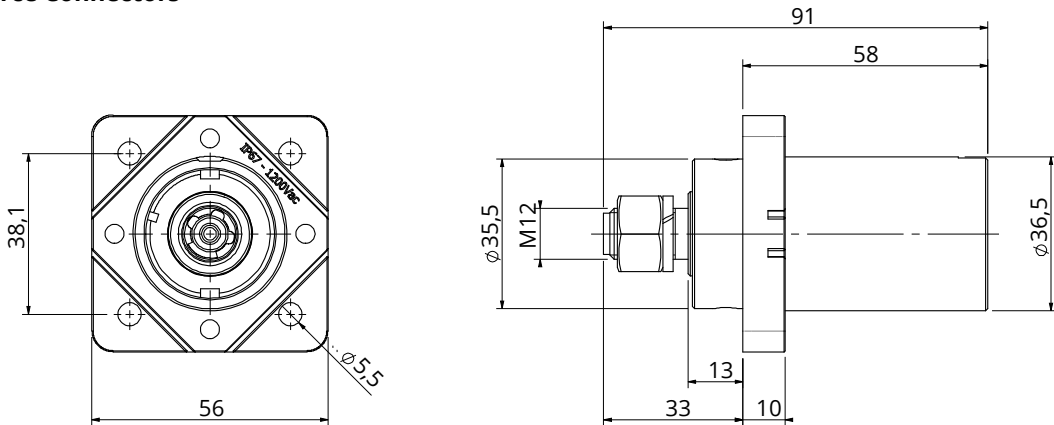

Panel Drain Connectors

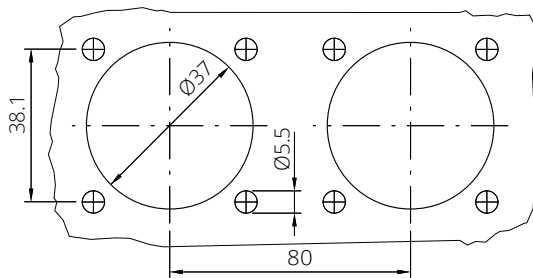
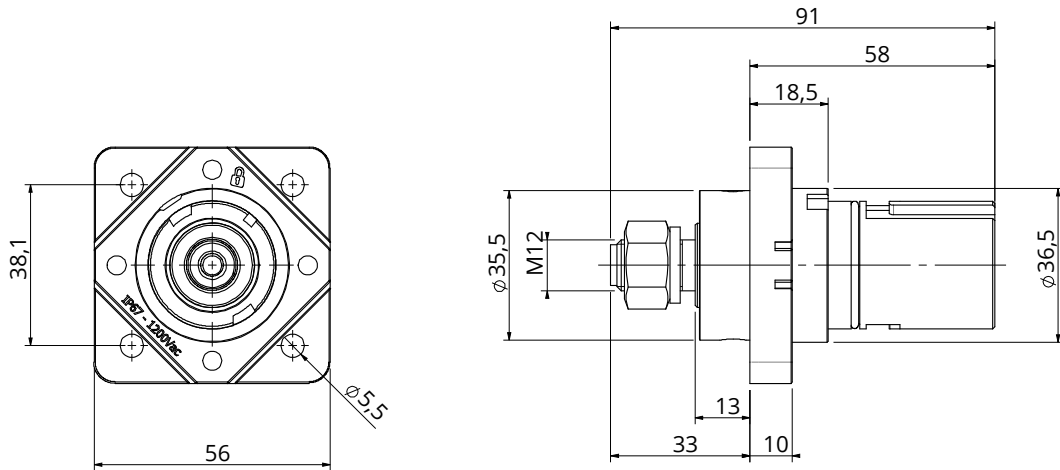

Panel cut out Source / Drain connectors

Panel Drain Connectors with Normally Open Microswitch

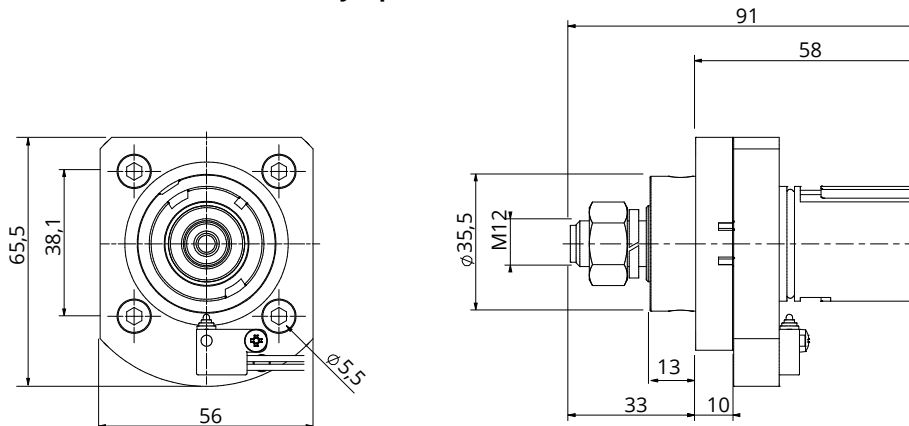

SPPC-HK Connectors - Dimensions

Cable/Line Source Connectors S/M (SPPC-HK-LS-xx-xx-x-xx-S / SPPC-HK-LS-xx-xx-x-xx-M)

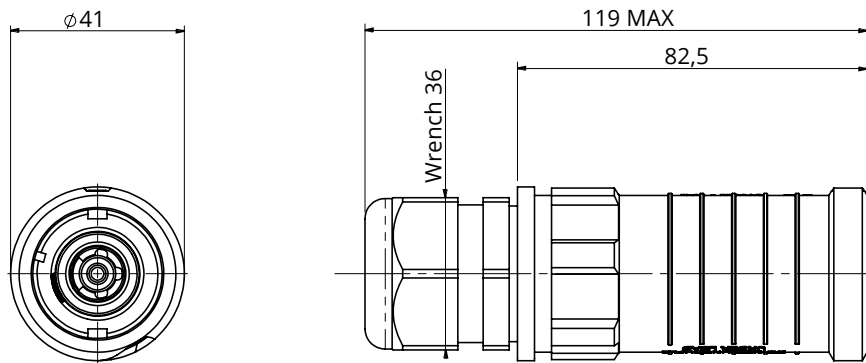

Cable/Line Source Connectors OS (SPPC-HK-LS-xx-xx-x-xx-OS)

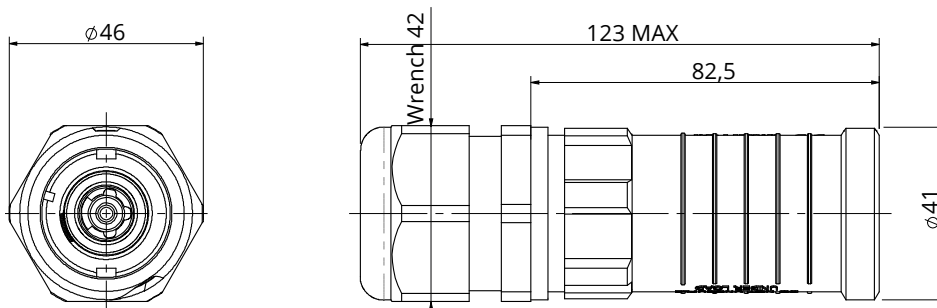

Cable/Line Drain Connectors S/M (SPPC-HK-LD-xx-xx-x-xx-S / SPPC-HK-LD-xx-xx-x-xx-M)

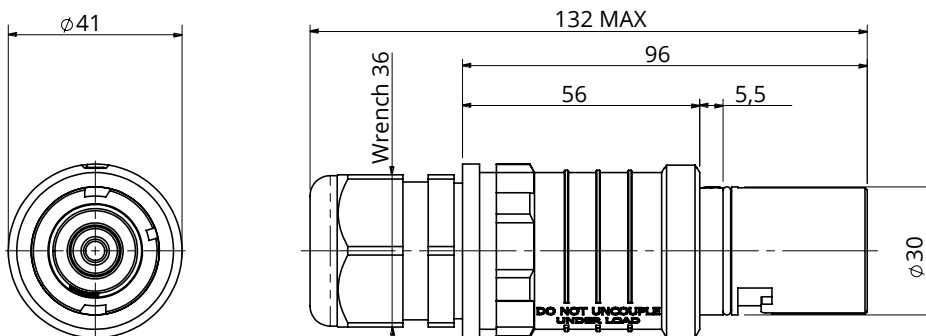

Cable/Line Drain Connectors OS (SPPC-HK-LD-xx-xx-x-xx-OS)

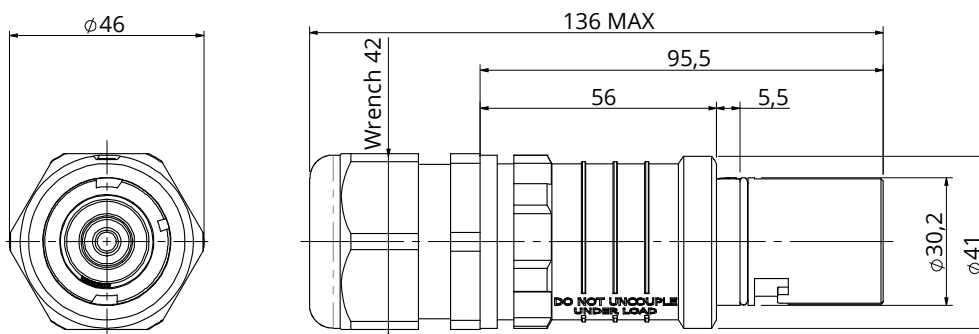





SPPC-HK Connectors - Cable/Line Connectors - 1200V - 250/400A

Cable/Line Source Connectors





Sleeves included, for cable conductor size - 16 mm² - 25 mm² - 35 mm² - 50 mm² - 70 mm² (for 16 mm² - 25 mm² see page 46)



250A - Screws terminal for conductor up to 70mm²

Color*	Short Description	Part Number
 Brown - Phase L1	SPPC-HK-LS-L1-BR-S-70-M	VS440075
 Black - Phase L2	SPPC-HK-LS-L2-BK-S-70-M	VS440055
 Grey - Phase L3	SPPC-HK-LS-L3-GY-S-70-M	VS440076
 Blue - Neutral	SPPC-HK-LS-N-BU-S-70-M	VS440077
 Green - Earth	SPPC-HK-LS-E-GN-S-70-M	VS440078

400A - Crimp contacts 95mm² - 120mm²





Color*	Short Description	Part Number
 Brown - Phase L1	SPPC-HK-LS-L1-BR-C-120-OS	VS440056
 Black - Phase L2	SPPC-HK-LS-L2-BK-C-120-OS	VS440057
 Grey - Phase L3	SPPC-HK-LS-L3-GY-C-120-OS	VS440062
 Blue - Neutral	SPPC-HK-LS-N-BU-C-120-OS	VS440064
 Green - Earth	SPPC-HK-LS-E-GN-C-120-OS	VS440063

Cable/Line Drain Connectors





Sleeves included, for cable conductor size - 16 mm² - 25 mm² - 35 mm² - 50 mm² - 70 mm² (for 16 mm² - 25 mm² see page 72)



250A - Screws terminal for conductor up to 70mm²

Color*	Short Description	Part Number
 Brown - Phase L1	SPPC-HK-LD-L1-BR-S-70-M	VS440002
 Black - Phase L2	SPPC-HK-LD-L2-BK-S-70-M	VS440054
 Grey - Phase L3	SPPC-HK-LD-L3-GY-S-70-M	VS440073
 Blue - Neutral	SPPC-HK-LD-N-BU-S-70-M	VS440074
 Green - Earth	SPPC-HK-LD-E-GN-S-70-M	VS440036

400A - Crimp contacts 95mm² - 120mm²

Color*	Short Description	Part Number
 Brown - Phase L1	SPPC-HK-LD-L1-BR-C-120-OS	VS440028
 Black - Phase L2	SPPC-HK-LD-L2-BK-C-120-OS	VS440029
 Grey - Phase L3	SPPC-HK-LD-L3-GY-C-120-OS	VS440030
 Blue - Neutral	SPPC-HK-LD-N-BU-C-120-OS	VS440027
 Green - Earth	SPPC-HK-LD-E-GN-C-120-OS	VS440026

*European Harmonized Color Set, others colors set on request

SPPC-HK Connectors - Panel Connectors - 1200V - 250/400A

Panel Source Connectors



250A - M12 Threaded post for conductor up to 70mm²

Color*	Short Description	Part Number
Brown - Phase L1	SPPC-HK-PS-L1-BR-M12-T2	VS440004
Black - Phase L2	SPPC-HK-PS-L2-BK-M12-T2	VS440017
Grey - Phase L3	SPPC-HK-PS-L3-GY-M12-T2	VS440071
Blue - Neutral	SPPC-HK-PS-N-BU-M12-T2	VS440072
Green - Earth	SPPC-HK-PS-E-GN-M12-T2	VS440018

400A - M12 Threaded post for conductor up to 120mm²

Color*	Short Description	Part Number
Brown - Phase L1	SPPC-HK-PS-L1-BR-M12-T4	VS440033
Black - Phase L2	SPPC-HK-PS-L2-BK-M12-T4	VS440034
Grey - Phase L3	SPPC-HK-PS-L3-GY-M12-T4	VS440035
Blue - Neutral	SPPC-HK-PS-N-BU-M12-T4	VS440032
Green - Earth	SPPC-HK-PS-E-GN-M12-T4	VS440031

Panel Drain Connectors



250A - M12 Threaded post for conductor up to 70mm²

Color*	Short Description	Part Number
Brown - Phase L1	SPPC-HK-PD-L1-BR-M12-T2	VS440024
Black - Phase L2	SPPC-HK-PD-L2-BK-M12-T2	VS440025
Grey - Phase L3	SPPC-HK-PD-L3-GY-M12-T2	VS440069
Blue - Neutral	SPPC-HK-PD-N-BU-M12-T2	VS440070
Green - Earth	SPPC-HK-PD-E-GN-M12-T2	VS440001

400A - M12 Threaded post for conductor up to 120mm²



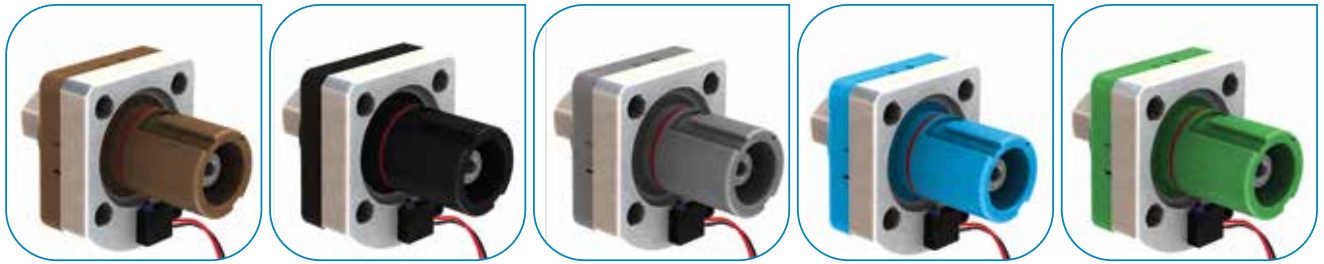

Color*	Short Description	Part Number
Brown - Phase L1	SPPC-HK-PD-L1-BR-M12-T4	VS440011
Black - Phase L2	SPPC-HK-PD-L2-BK-M12-T4	VS440065
Grey - Phase L3	SPPC-HK-PD-L3-GY-M12-T4	VS440066
Blue - Neutral	SPPC-HK-PD-N-BU-M12-T4	VS440068
Green - Earth	SPPC-HK-PD-E-GN-M12-T4	VS440067

*European Harmonized Color Set, others colors set on request





SPPC-HK Connectors - Panel Drain Connectors - 1200V - 250/400A with Normally Open Microswitch



250A - M12 Threaded post for conductor up to 70mm²

Color*	Short Description	Part Number
 Brown - Phase L1	SPPC-HK-PD-L1-BR-M12-T2-SW	on request
 Black - Phase L2	SPPC-HK-PD-L2-BK-M12-T2-SW	on request
 Grey - Phase L3	SPPC-HK-PD-L3-GY-M12-T2-SW	on request
 Blue - Neutral	SPPC-HK-PD-N-BU-M12-T2-SW	on request
 Green - Earth	SPPC-HK-PD-E-GN-M12-T2-SW	on request

400A - M12 Threaded post for conductor up to 120mm²

Color*	Short Description	Part Number
 Brown - Phase L1	SPPC-HK-PD-L1-BR-M12-T4-SW	on request
 Black - Phase L2	SPPC-HK-PD-L2-BK-M12-T4-SW	on request
 Grey - Phase L3	SPPC-HK-PD-L3-GY-M12-T4-SW	on request
 Blue - Neutral	SPPC-HK-PD-N-BU-M12-T4-SW	on request
 Green - Earth	SPPC-HK-PD-E-GN-M12-T4-SW	on request

**European Harmonized Color Set, others colors set on request*

SPPC-HK Connectors - Crimping Tool

It is recommended to apply multiple crimp compressions in accordance with the above table to obtain optimum mechanical and electrical performance.

The correct sequence of compressions is shown in Fig.2.

Use the following tool:

- Hand operated crimp tool: HT120

Due to the numerous cable types available, it is recommended to contact our Customer Service to confirm cable & crimp suitability.

Cable Size	Up to 70mm ²	95mm ²	120mm ² AWG 4/0
Insulation Strip (dim L)	26mm	20mm	20mm
Recommended Number of Crimps	N/A (set screw)	2	2
Hand Operated Crimp Tool	N/A	HT120	HT120
Crimp Die Set	N/A	ME24-C	ME29-C
Contact Removal Tool	VS750070	VS750070	VS750070

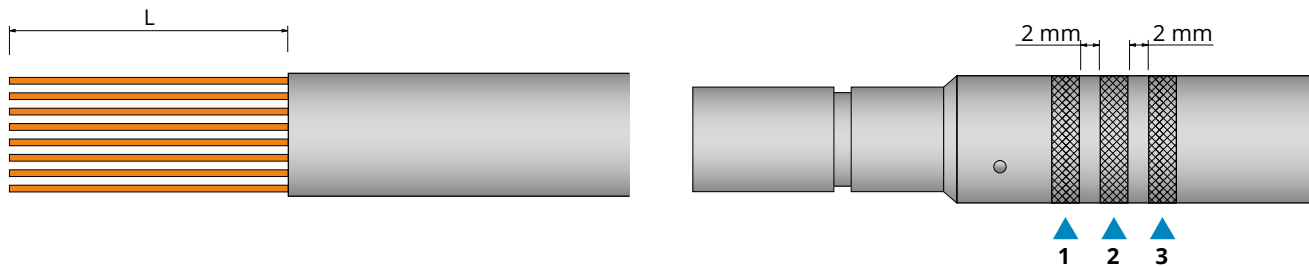

Fig.2

Hand Operated Crimp Tool HT120



SPPC-HK Connectors - Accessories



Cable Gland - for Cable/Line Connectors

Type	Short Description	Part Number
M32 threaded 7mm - 15mm	SPPC-HK-M32-S	VS750061
M32 threaded 11mm-21mm	SPPC-HK-M32-M	VS750060
M32 threaded 15mm-25mm	SPPC-HK-M32-OS	*

* On request

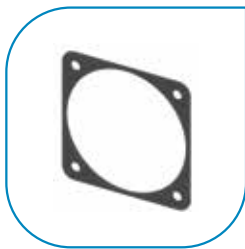

Panel Gasket

Type	Short Description	Part Number
Neoprene Gaskets	SPPC-HK-PG	750032



Sleeve For Screw Terminal for cable conductor size - 16 mm² - 25 mm²

Type	Short Description	Part Number
Sleeve	SPPC-HK-SL1625	VS750064

It is mandatory to use the bolts supplied with the kit

SPPC-HK Connectors - Contact Removal Tool

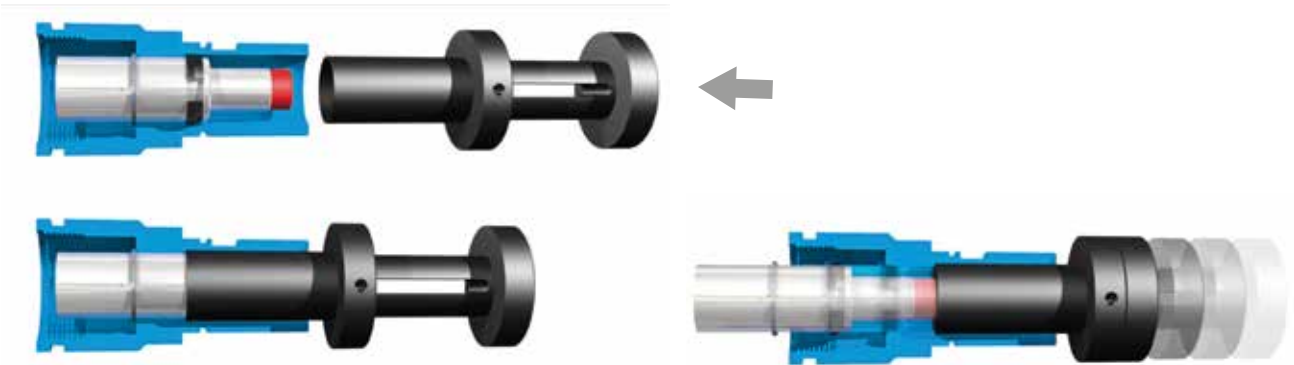

The contacts are inserted from the rear and snap into position within the insulator with no requirements for any cotter/dowel pin or assembly tool. The contacts are removed from the insulator by using a simple tool to release the retaining clip.

- Improved mechanical insulator strength
- Reliable sealing
- Improved electrical integrity of the insulator
- Reduced assembly times
- The contacts can be removed and replaced

No replacement parts (cotter/dowel pins) are required.

Type	Short Description	Part Number
Crimp and Screw contacts	SPPC-HK-RT	VS750070

SPPC-HK Connectors

Derating data for 85°C rubber insulated cables

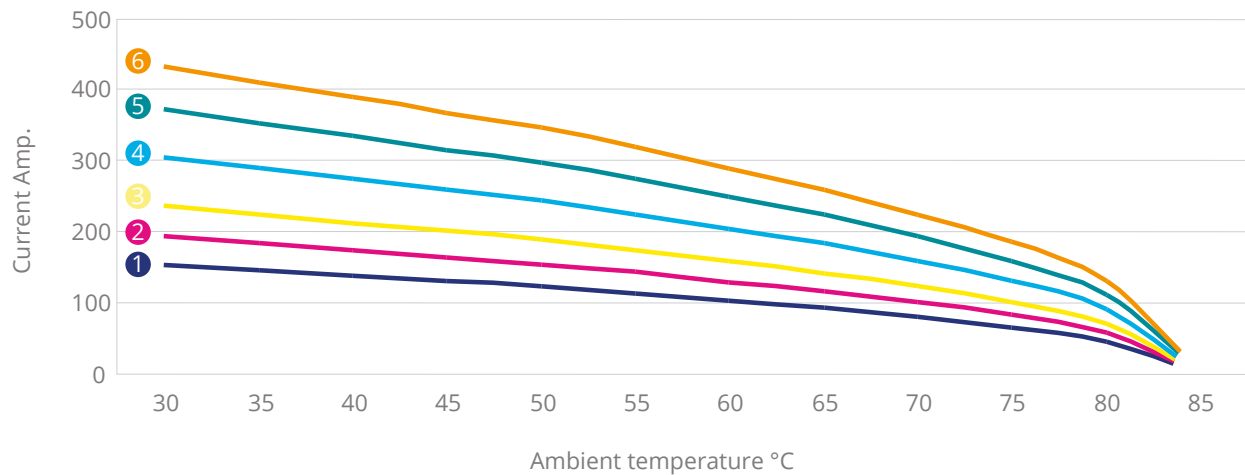

① 25mm² ② 35mm² ③ 50mm² ④ 70mm² ⑤ 95mm² ⑥ 120mm²

Characteristics

Operating Voltage	1200V AC or DC
Maximum panel thickness to guarantee insulation	6mm
Panel contact tightening torque	30Nm Max
Screws tightening torque (in-line connectors)	12Nm
Contact retention in Insulator	400N axial load
Inline contact retention	Plastic Clip
Panel mount contact retention	Dowel Pin
Contact release	Front
M32 Clamping range	7mm ÷ 25mm
Flammability	UL94 V0
Environmental sealing (when mated)	IP67
Connector protection (unmated)	IP2X
Rated voltage to Earth	1750Vac, panel thickness<4mm 1200Vac, panel thickness>4mm
Contact resistance	<0.1mΩ
Short circuit current	11KA - 1 seconds
Short circuit current	4KA - 3 seconds
Surge current (din VDE 0102/1.90)	45KA - 10 mseconds
Temperature range	-30°C/+120°C

SPPC-LJP Connectors - Introduction

LUG-IT - Power cable joining system



LUG-IT 300



LUG-IT 120



SPPC-LJP Connectors - Introduction

LUG-IT - Power cable joining system



LUG-IT 300



LUG-IT 120

LUG-IT is a safe and efficient means to make temporary connection / extensions of single core power cables that are pre-terminated with copper lug terminals.

APPLICATIONS

- Power distribution
- Utilities
- Electric Vehicles
- Railway Equipment
- Military Field Power
- Mobile Generators
- Loadbanks
- Back-up Power Systems

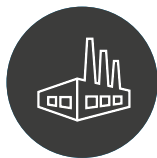

KEY CHARACTERISTICS

- Increase cable utilization
- Reusable
- Suitable for temporary connections
- Standardize on cable lengths held in stock
- Decrease cable purchase
- Reduce transportation of cables between sites
- No need for connectors or junction boxes
- Daisy chain hook up system

DETAILS

- Nominal Voltage Un: 1000Vac
- 2 Lug-it sizes available according to the lug and cable dimensions:
 - LJP-120 from 35mm² up to 120mm²
 - LJP-300 from 185mm² up to 300mm².
- Test voltage: 5.000Vac
- Rated current (to be checked with the specific cable characteristics):
 - Lugs 120 mm²:350A (30°C)
 - Lugs 185 mm²:570A (30°C)
 - Lugs 240 mm²:670A (30°C)
 - Lugs 300 mm²:780A (30°C)
- Working temperature: -30°C ÷ +120°C
- Protection degree: IP67 (EN 60529)
- Audible and tactile indication of locking
- Secure lock for unwanted / unauthorised release
- Quick assembly in approx. 2 minutes without special tools. The system can be disassembled and reused

SPPC-LJP Connectors - Dimensions

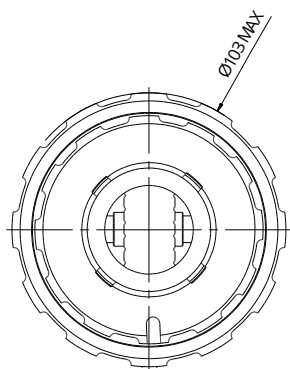

LUG-IT 300

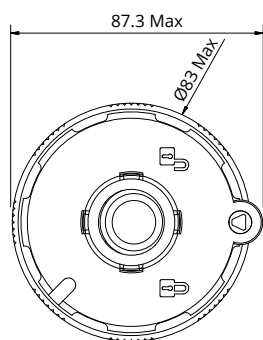
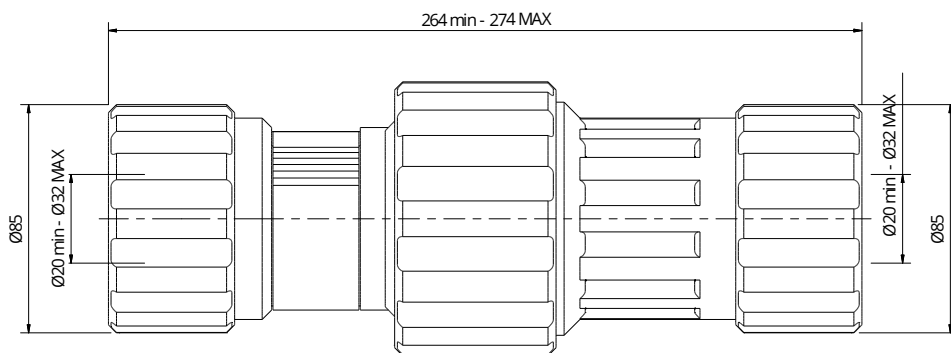

LUG-IT 120

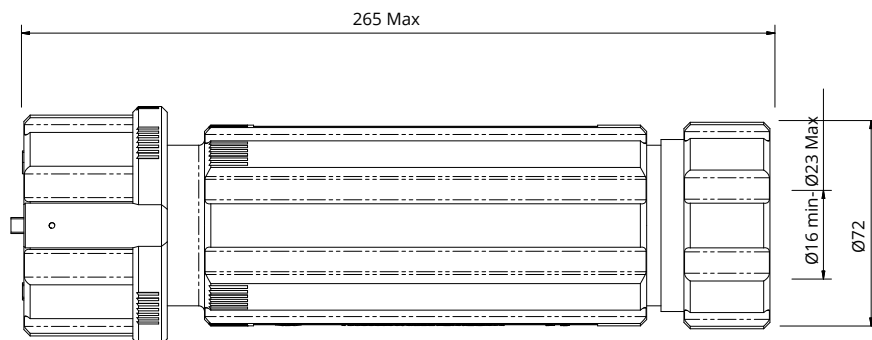

Materials and finishes

Shells	thermoplastic resin
Contact-parts	copper alloy
Gaskets	silicone compound
Other parts	thermoplastic resin and stainless steel

SPPC-LJP Connectors - LUG-IT 300 - 1000V



Accepts cables 185mm², 240mm² and 300mm², for lugs with 12mm holes, Lug Palm Width 45mm max, Bolt Hole 12mm, External Cable Ø 20mm - 32mm.

Short Description

SPPC-LJP-300

Part Number

VS354801

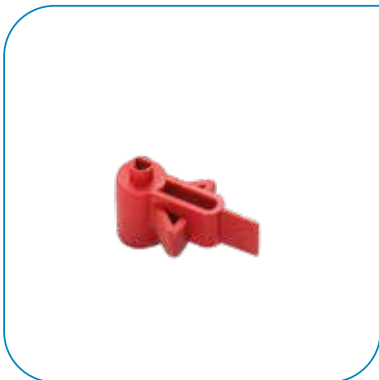

LUG-IT KEY

remote locking/release key

Short Description

SPPC-LJP-KEY

Part Number

VS750082

Lock the central locking ring using the remote release key.



SPPC-LJP Connectors - LUG-IT 300



Assemble component parts over the lugs and onto the cables. The special gaskets easily allow this step.

Lug Palm Width 45mm max, Bolt Hole 12mm,

Terminate the lugs into the joining block using the correct lugs shoulders. The system is designed to avoid using any loose parts.

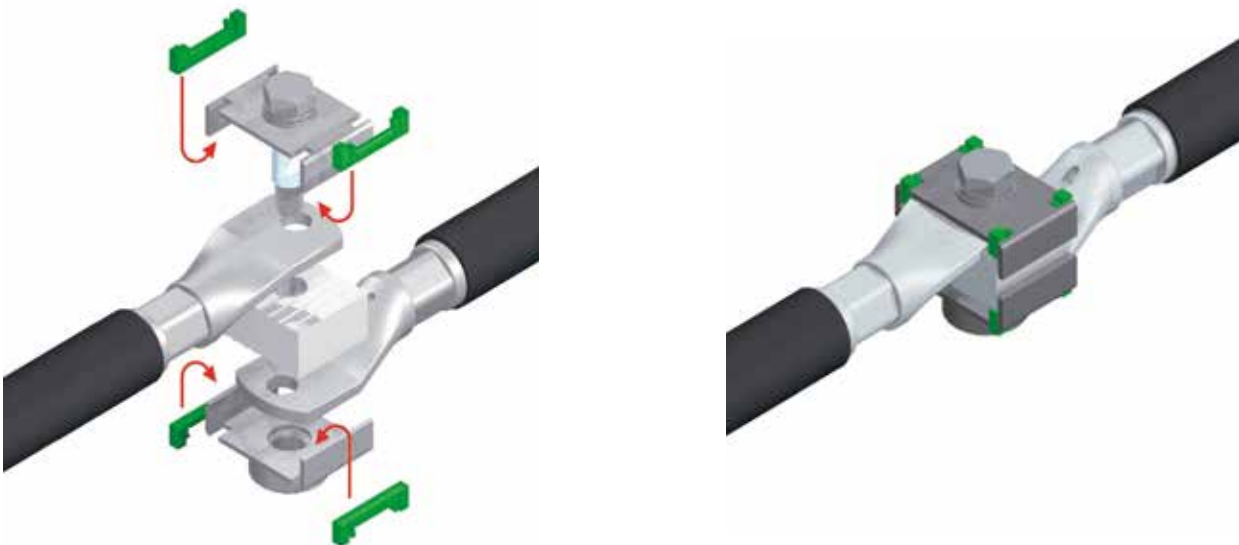

Ensure the back shell keyways are correctly positioned to mate with each other.

Rotate the central locking ring till it snaps into fully mated position. Tighten the two back nuts.



SPPC-LJP Connectors - LUG-IT 120 - 1000V



Accepts cable 35mm² up to 120mm², for lugs with 8,2mm holes, Lug Palm Width 30mm max, Bolt Hole 10mm or 12mm, External Cable Ø 16mm – 23mm.

Short Description

SPPC-LJP-120

Part Number

VS354804



LUG-IT KEY

remote locking/release key

Short Description

SPPC-LJP-KEY

Part Number

VS750082

Lock the central locking ring using the remote release key.



Lug Palm Width 30mm max, Bolt Hole 10mm or 12mm.

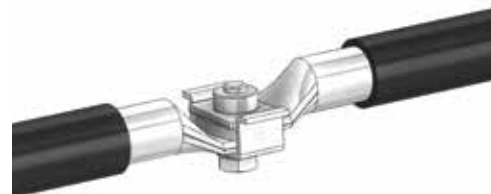
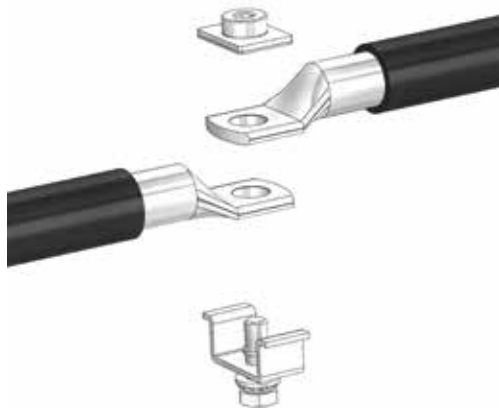

Information regarding the use of the product within recommended safety limits

To use the connectors described in this catalogue according to the necessary safety requirements we suggest you apply the following criteria:

- use the connectors and connected cables within their electrical and environmental limits
- follow the characteristics of each version and carefully choose the appropriate connector for the required use
- make sure to respect the procedures regarding the correct assembly of connectors and the crimping of contacts
- any connector damaged during shipment, storage, assembly or use should be replaced
- never uncouple the connectors when under power
- always protect the parts against shock when the circuit is under power
- always check the circuit before putting it under power
- the user must take final responsibility for electrical safety.

For the instructions concerning assembly and crimping of contacts please consult the appropriate tools manuals.

We recommend to respect the following general rules:

- Always use the tools recommended by Radiall Italia Srl's catalogue or manuals
- Use the suggested norms for tool maintenance and calibration

Consult Radiall Italia Srl if in doubt.

DO NOT USE ALTERNATIVE GREASES OR OILS which could damage the Sequential Box and affect the functionality of the connector. Radiall Italia Srl reserves the right to amend the specifications of this instruction without issuing prior notice.

SAFETY PRECAUTIONS:

Carefully read the safety instructions before using S-Box product.

- Make sure that the current of the cables and connectors being used are suitable for the S-Box current rating.
- The cables must not be connected under voltage.
- Connectors must not be connected or disconnected when live or under load. The voltage power must be switched off before connection/disconnection.
- The contacts must be checked before assembly to ensure there is no damage on them before starting the next assembly step.

The data defined in this document are given as an indication. In the effort to improve our products, we reserve the right to make any change judged necessary.



www.radiall.com

FRANCE

RADIALL S.A.
Tel +33149353535
info@radiall.com



www.vansystem.eu

ITALY

Radiall Italia S.r.l.
Tel. +39023569931
infoit@radiall.com

2024 EDITION

Rev_02.2024

050.SPCC_S-BOX015
PRINTED IN ITALY